



Research Centre on  
ZERO EMISSION  
NEIGHBOURHOODS  
IN SMART CITIES

# ANNUAL REPORT 2020





**VISION:**  
**«Sustainable  
neighbourhoods  
with zero  
greenhouse gas  
emissions»**

ZEN REPORT No. 31 – 2021

**Editors:** Ann Kristin Kvellheim (SINTEF), Sunniva Moum Danielsen (NTNU), Anne Grete Hestnes (NTNU) and Arild Gustavsen (NTNU).

**Annual Report 2020**

**Photo:** If not stated otherwise, all photographs and illustrations in this annual report are by NTNU, SINTEF or other ZEN partners.  
Front page picture: © Sunniva Moum Danielsen

**Copyright:** Research Centre on Zero Emission Neighbourhoods in Smart Cities (FME ZEN), 2020.

ISBN 978-82-536-1691-9

Norwegian University of Science and Technology (NTNU) | [www.ntnu.no](http://www.ntnu.no)

SINTEF Community | [www.SINTEF.no/community](http://www.SINTEF.no/community)

<https://fmezen.no>

# CONTENTS

The importance of Zero Emission Neighbourhoods .....	4
ZEN activities in a different year .....	5
Innovation in the ZEN Research Centre .....	8
Organisation of the ZEN Research Centre .....	9
Our partners .....	10
Our laboratories .....	11
<b>SNAPSHOTS OF OUR RESEARCH</b> .....	<b>13</b>
Evaluation of parallel design options for New city – new airport in Bodø .....	14
<i>Evaluering av planforslag for Ny by – ny flyplass i Bodø</i> .....	15
Opportunities and limitations for additional floors in wood to existing apartment blocks .....	16
<i>Muligheter og begrensninger ved påbygg med tremoduler på eksisterende boligblokker</i> .....	17
Model predictive control of heating systems for utilization of building flexibility .....	18
<i>Prediktiv styring av oppvarmingssystemer for utnyttelse av fleksibilitet</i> .....	19
How zero-emission areas in Norway affect the European power market .....	20
<i>Slik påvirker nullutslippsområder i Norge det europeiske kraftmarkedet</i> .....	21
Ydalir living lab: The good life .....	22
<i>Ydalir living lab: Det gode liv</i> .....	23
Can demand controlled ventilation (DCV) with heat recovery achieve dual centred victory (DCV)? .....	24
<i>Bedre design av behovsstyrt ventilasjon og varmegjenvinning med livsløpsanalyse?</i> .....	25
Energy system optimization for everyone – here comes the web-based version of eTransport .....	26
<i>Et verktøy for energi-systemanalyser for alle – her kommer web-versjonen av eTransport</i> .....	27
Material embodied emissions from buildings in zero emission neighbourhoods .....	28
<i>Materialrelaterte utslipp fra bygninger i nullutslippsområder</i> .....	29
Involving citizens on our journey towards zero emission neighbourhoods .....	30
<i>Innbyggerne må tas med på reisen mot nullutslippsområdene</i> .....	31
Domestic hot water – typical profiles .....	32
<i>Typiske lastprofiler for oppvarming av varmt tappevann i bygg</i> .....	33
Possibilities and limitations in current legislations when developing a ZEN area .....	34
<i>Utfordringer og muligheter i dagens lovverk ved etablering av nullutslippsområder</i> .....	35
CASE RISVOLLAN: Alternative energy supply scenarios for an existing housing cooperative .....	36
<i>CASE RISVOLLAN: Alternative energiforsyningsscenarier for et eksisterende borettslag</i> .....	37
A first real implementation of MPC in the ZEB living lab .....	38
<i>En første implementering av MPC på ZEB living lab</i> .....	39
Communication at the ZEN Research Centre .....	40
Collaboration among our partners .....	43
International cooperation at the ZEN Research Centre .....	45
Researcher training and recruitment .....	47
<b>APPENDICES:</b> .....	<b>49</b>
Personell .....	50
Statement of accounts .....	55
Publications in 2020 .....	57

# THE IMPORTANCE OF ZERO EMISSION NEIGHBOURHOODS



**Tonje Frydenlund**  
Chair of the Board  
at the ZEN Research Centre,  
Snøhetta

Six years ago, in 2015, the Paris Agreement ensured global commitments were made to reach net-zero carbon emissions by mid-century to limit global warming to 1.5°C and minimize its negative impacts on the ecosystem. 4 years ago, in 2017, 20 industry partners, 11 public partners and municipalities and 2 research partners and host institutions, established the Research Center on Zero Emission Neighbourhoods in Smart Cities supported by the Research Council of Norway.

The FME ZEN partners cover the entire value chain and include representatives from municipal and regional governments, property owners, developers, engineers, consultants and architects, ICT companies, contractors, energy companies, manufacturers of materials and products and governmental organizations. The ZEN Research Centre develops solutions for future buildings and Neighbourhoods with no greenhouse gas emissions and thereby contributes to a low carbon society.

The Paris agreement is a global commitment to combat climate change, and fortunately a growing number of countries are making commitments to achieve carbon neutrality, or “net zero” emissions within the next few decades. It is a tremendous task and requires ambitious actions starting right now. We are not yet on track to meet agreed targets in the Paris agreement, which stipulated

keeping global temperature increase well below 2 °C or at 1.5 °C above pre-industrial levels. The last decade has been the warmest on record. On the current path of carbon dioxide emissions, the global temperature is expected to increase by 3 to 5 degrees Celsius by the end of century.

Put simply; we must act now!

We are all responsible as individuals, in terms of changing our habits and living in a way which is more sustainable, and which does less harm to the planet. We must engage and be engaged as citizens and professionals in the development of sustainable solutions. We must challenge the current market with innovative business models and efficient solutions. Grasp opportunities provided by technology development and digitalization, and create new business partnerships across disciplines, sectors, and traditional market chains. The remarkable year of 2020 has shown us that we can change and adapt when needed.

The ZEN Centre has 9 pilot projects spread across Norway with an area of more than 1 million m<sup>2</sup>, creating sustainable Neighbourhoods for over 30 000 inhabitants in total. Best practice projects and examples through cases and living labs are essential for learning and gaining in-depth knowledge. Only through actual testing and measuring we will be able to give advice on how to further develop our future sustainable Neighbourhoods and smart cities. We will through the pilots and living labs create a demand and supply for Zero emission solutions through ambitious goals and long-term value creation. We engage users in co-creating attractive Neighbourhoods,

and we support innovative approaches and acquire new knowledge on energy transition, zero emission materials, and smart technology.

Halfway into the Research Centre activities we already see results from case studies, the work package research activities, pilot projects, and living labs. Our research and innovations are unique in a global perspective, especially when it comes to the holistic approach and enabling the transition to a low carbon society. With the ZEN-definition, criteria, and tools in place, the ZEN Research Centre with partners will contribute to changing both the industry and the society at large. Our mission is to share insight, inspire, and support the necessary actions to ensure optimal energy use, zero emission building, sustainable Neighbourhoods, and smart cities. Our research and shared knowledge and insight is of great importance to the future development. Thank you!

## Centre Board

Anders Fylling, Statsbygg  
Anna-Thekla Tonjer, Elverum vekst  
Fredrik Shetelig, NTNU  
Jo Mortensen, Skanska Norway  
Leif Øie, GK  
Partow P. Henriksen, SINTEF  
Svein Olav Munkeby, NTE  
Tonje Frydenlund, Snøhetta

# ZEN ACTIVITIES IN A DIFFERENT YEAR



**Arild Gustavsen**  
Centre director  
Professor, ZEN, NTNU

The Research Centre on Zero Emission Neighbourhoods (ZEN) in Smart Cities organized our general assembly March 11th, 2020, the last day before Norway closed down due to the Corona virus. The event was organized as a mixed physical and virtual meeting, setting the standard for meetings and gatherings during the remaining part of 2020. Even if 2020 has been a very different year compared to a regular year and we miss the typical physical meeting arenas, the ZEN Research Centre has continued its activities (mostly) according to the developed plan. Research, development and innovation activities have continued, and stronger partner collaboration has been sought through the ZEN Pilot Projects and initiation of more ZEN Cases.

## RESEARCH AND DEVELOPMENT ACTIVITIES

The Centre has continued to evaluate the zero-emission neighbourhood definition. Overall findings indicate that it is challenging to achieve net zero greenhouse gas (GHG) emissions at the neighbourhood level, given how projects are designed today. There is a need for much stronger attention to minimizing material embodied emissions, to creating a surplus generation of renewable energy that can off-set emissions from fossil energy generation or use elsewhere, and to ensuring substantially lower emissions from mobility than what is common today.

Life cycle assessment (LCA) is used to calculate potential greenhouse gas emissions from ZEN projects and associated solutions. When comparing building materials and solutions we find that an increased level of detail is necessary to reach correct conclusions. To make detailed LCA analysis of ventilation systems possible, a database has been prepared,

with most components that are part of ventilation plants. This provides greater opportunities for calculating and balancing environmental impacts associated with material use and operation. Furthermore, a novel approach for building performance robustness assessment has been introduced. The results show that the proposed approach can select a high performance and robust building design simultaneously with less analysis effort.

A suite of models and tools is under development, which enables the study of buildings' energy loads (with hourly resolution), and how to modify them. This is done by gathering and structuring knowledge on today's typical energy demand profiles from measurements (database trEASURE and load profile generator PROFet) and then changing tomorrow's demand by implementing demand response in buildings and neighborhoods, thus obtaining flexible energy loads that deviate from the typical ones. The tool eTransport is used in



the evaluation of alternative energy system configurations for confined areas. The model minimizes total system costs within a given planning period, subject to hourly energy demands, options for further development, and limitations of the existing energy system. The model includes multiple energy carriers and also electric and thermal energy storage. In another tool, EMPIRE, the impact of ZENs and ZEN-solutions on the power system has been explored. One finding is that reduced use of electricity in Norwegian buildings can increase the contribution from Norwegian hydropower in Europe.

A conceptual model for strategic procurement implementation in complex systems and programs (like ZENs) has been suggested. Further, the innovation system has a significant impact on the development of zero emission neighbourhoods, therefore, innovation ecosystem analysis is undertaken, as well as exploration of new business models in relevant industries. Innovative solutions, some of which are important to realize the ZEN-ambition, can be in conflict with current legislation. Challenges and opportunities have in particular been identified in connection with the Plan- and building act as well as the Energy act.

Several of the activities are connected to the pilot projects. A method based on geographical information system (GIS) has been used to analyze spatial conditions essential to carbon emissions in neighbourhoods. This method was recently applied to evaluate three different proposals for the development of the Bodø NyBy area. Further, based on an analysis of existing living labs and a literature study, a definition for civic ZEN living labs was developed and explored.

Civic living labs allow for the analysis of end-user-related barriers and help overcome these by providing knowledge about end-users' needs and demands and supporting citizen participation.

### NEW IDEAS AND INNOVATION

The ZEN pilot projects, located from Bærum in the south, to Bodø in the north, are our most important innovation arenas. Here researchers and partners meet, and innovations are tested and demonstrated. New ideas and innovations are noted and followed

up on in the ZEN innovation registration system. We record the following information per idea: Number on the Technology Readiness Level (TRL) scale (in each year: 2017-2024), type of innovation, who is involved, a description of the idea, market potential and potential impact. Goals are set related to the increasing TRL and how the idea can reach the market in the form of socially beneficial products or services. Thirty-two innovations have been described in the first ZEN Innovation Report published in October 2020.



## INTERNATIONAL COLLABORATION AND DISSEMINATION

Researchers in the ZEN Research Centre collaborates and presents their results internationally in several ways. The EU H2020 project **syn.ikia** on *Sustainable Positive Energy Neighbourhoods*, hosted by NTNU, started in January 2020, with thirteen industry and research partners. NTNU and SINTEF are also part of the newly funded project EU H2020 **iclimate-built** on *Functional and advanced insulating and energy harvesting/storage materials across climate adaptive building*

*envelopes*, to be started in 2021. Several of the researchers are part of International Energy Agency Annexes and Tasks, and researchers regularly present their results at international conferences. Two of the PhD candidates received awards for their work in 2020: Xingji Yu received the Best-Paper-Award for his paper at the Build-Sim-Nordic 2020 Conference. Kasper Emil Thorvaldsen got the Roy Billinton Best-student-paper award for his paper presented at the Probabilistic Methods Applied to Power Systems Conference 2020. As of December 2020, our ZEN Centre has published close to 150 scientific reports and

articles, 33 popular science publications, 155 media publications (in newspapers, radio, or TV), and 270 reports, memoranda, articles, and presentations held at meetings or conferences for project target groups. Our website ([www.fmezen.no](http://www.fmezen.no)) now has more than 21.000 users and is currently in the process of being translated into Norwegian.

Snapshots of our research, development and innovation activities are presented in the following chapters. Enjoy reading!



# INNOVATION IN THE ZEN RESEARCH CENTRE

The year 2020 has presented the ZEN Centre with unique challenges, resulting in researchers and partners having to adapt and work in new ways. For ZEN, pilot projects are our most important innovation arenas. With that said, innovations are best nurtured through the interactions between actors. The flow of interactions has been more difficult in 2020, however, research and innovation activities has continued as much as possible.

Several publications have come out in 2020 where innovation in ZEN has been the focus. In one report<sup>1</sup>, seven of the FME centres collaborated describing their approach to, and work with innovation. Collaboration across the FMEs commenced in 2018, and it continues to offer a useful exchange of common issues of interest among the FMEs.

A milestone in 2020 was the publishing in October of the first innovation report in ZEN. In this report, 32 innovations and innovation-ideas are presented, starting with innovations that are tested in one or more of the pilot projects. This report serves as a point of departure for further discussions about the innovation work in ZEN, and it will be used to progress this work further. This include ensuring partner collaboration, as well as exploiting the potential for commercialization.

The ZEN innovation committee (see text box) has been an important resource for the centre management through 2020. The committee contributes to the establishment of excellence in innovation processes in terms of the interface between the user-partners and the research-partners. The committee



also acts to ensure the execution of the innovation work plan established for the period 2020-2021.

The ZEN Centre will continue to focus on increasing innovation and the capacity for knowledge transfer in collaboration with the public and private sector. The goal is to increase the impact of innovation; to identify ideas with the potential to become new innovations; to further develop an innovation culture; and to increase collaboration in clusters and centres where ZEN participates.

## The innovation committee members are:

Svein Olav Munkeby, NTE Marked AS (leader)  
Zdena Cervenka, Statsbygg  
Morten Dybesland, Statsbygg  
Stein Stoknes, FutureBuilt  
Rakel Hunstad, Bodø municipality

Kai Haakon Kristensen, Bodø municipality  
Shannon Truloff (from 2021), NTNU  
Elsebeth Holmen, NTNU  
Terje Jacobsen, SINTEF Community  
Ann Kristin Kvellheim, SINTEF Community

<sup>1</sup> Innovasjonsarbeid i FME-ene, 2020





# ORGANISATION OF THE ZEN RESEARCH CENTRE

The ZEN Research Centre is a Centre for Environment-friendly Energy Research (FME) and was established in 2017 by the Research Council of Norway. The Centre is hosted by the Norwegian University of Science and Technology, and jointly organised by NTNU/SINTEF.

The ZEN Research Centre has a General Assembly and an Executive Board. The Executive Board (EB) is responsible for the quality and progress of the research activities and for the allocation of funds to support the various activities. The user partners have the majority and the Chair of the EB. The General Assembly (GA) includes a representative from each of the partners. The GA gives guidance to the EB in their decision-making on major project management issues and approval of the semi-annual implementation plans.

The Centre also has a Scientific Committee (SC) with representatives from leading international institutes and universities to ensure international relevance and quality of the work performed. The SC consists of selected representatives from the Centre's international partners, who have been selected because their competence is relevant for the Centre's research activities.

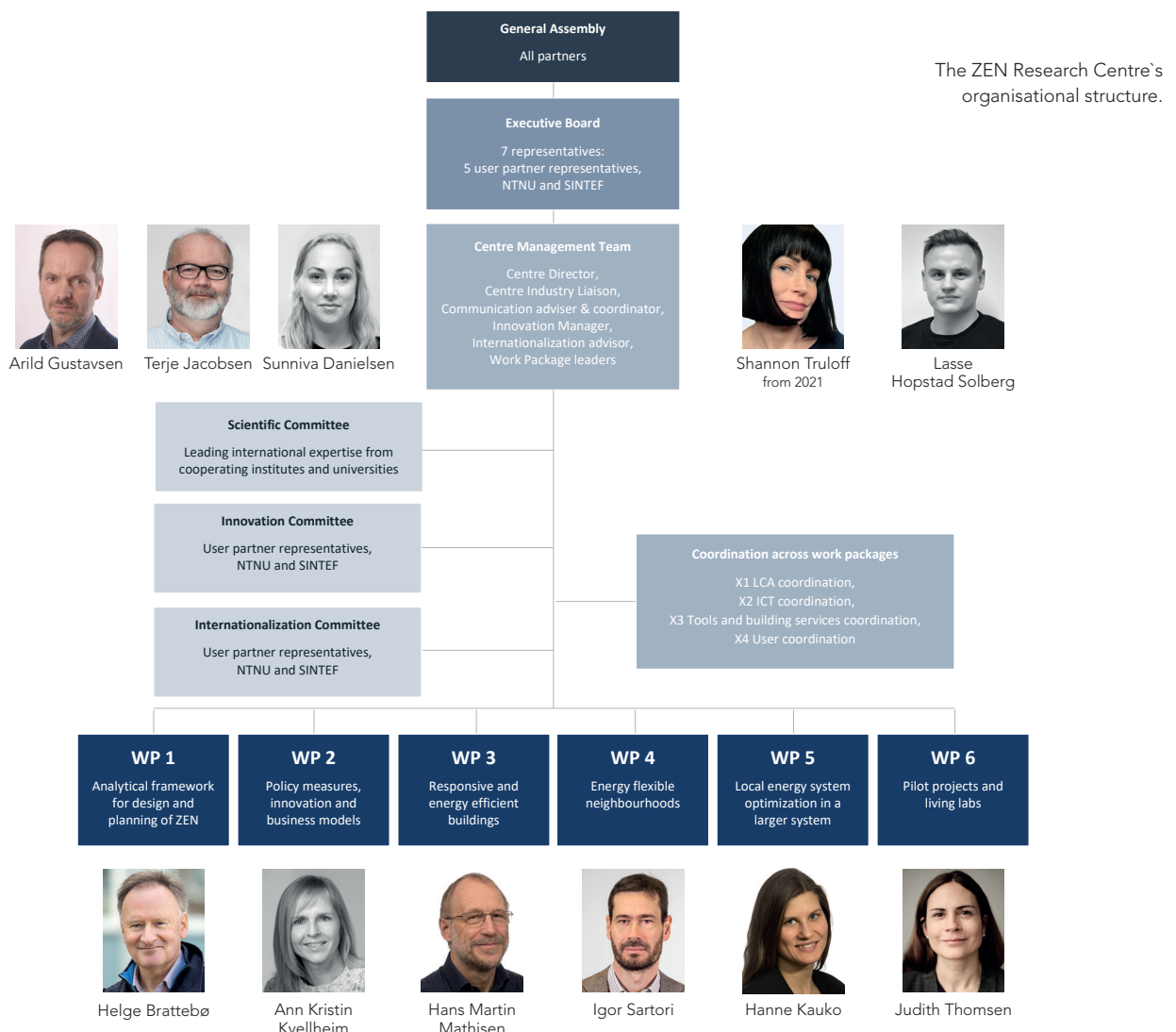

# OUR PARTNERS

The partners in the ZEN Research Centre hold central roles within the design and development of neighbourhoods and the energy system. This includes representatives from municipal and regional governments, property owners, developers, consultants and architects, ICT companies, contractors, energy companies, manufacturers of materials and products, and governmental organisations. The Norwegian University of Science and Technology (NTNU) is the host and leads the Centre together with SINTEF Community and SINTEF Energy Research.



# OUR LABORATORIES

We have systematically developed our laboratories through the FME Zero Emission Buildings and several other projects, and we continue to do so in the ZEN Research Centre. Our laboratories are being used by our researchers and partners within user cases and the work packages. Examples of lab research activities can be explored in the snapshots-chapters in this annual report. In addition to the labs below, several of our pilot projects function as living labs.

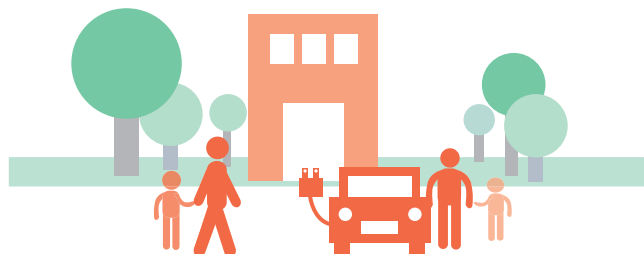

## ZEB Living Lab



Photo: Geir Mogen



Photo: Leikny Havik Skjærseth

**More information:**

<http://zeb.no/index.php/en/living-lab-trondheim>

## ZEB Test Cell

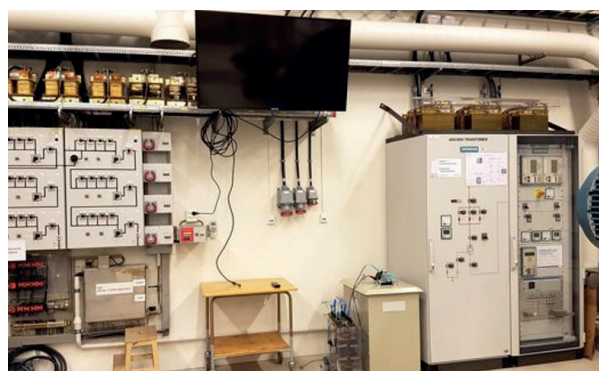

Photo: Nicola Lilli, SINTEF

**More information:**

<http://zeb.no/index.php/en/test-cell-laboratory>

## Smart Grid Laboratory



Distribution network with two departures / radials.

**More information:**

<https://www.ntnu.edu/smartgrid>

## ZEB Laboratory

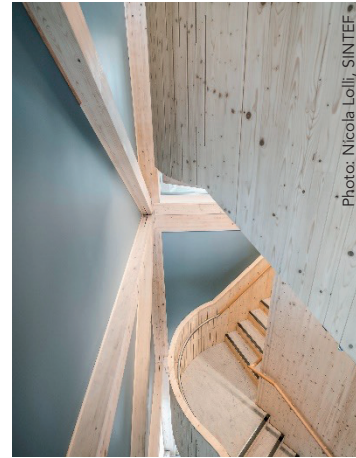

ZEB lab is a laboratory for zero emission buildings (ZEB) – an arena where new and innovative materials and solutions are developed, investigated, tested and demonstrated in mutual interaction with people. The construction of the laboratory was completed in the fall 2020.

More information: <http://zeblab.no/>

## Snapshots from meetings with partners



More information: <https://www.ntnu.edu/smartgrid>

# SNAPSHOTS OF OUR RESEARCH



# Evaluation of parallel design options for New city – new airport in Bodø



**Bendik Manum**  
Professor,  
NTNU



**Tobias Nordström**  
Assistant Professor,  
NTNU



**Lillian Rokseth**  
PhD candidate,  
NTNU



**Kristoffer L. Seivåg**  
Area planner,  
Bodø municipality

The research group ZEN-SMS (Spatial Morphology Studies in ZEN) at NTNU, Faculty of Architecture and Design (NTNU-AD) has developed GIS-based analysis tools to measure and evaluate characteristics of urban form that are important for urban qualities and for sustainable mobility. The analysis has previously been used to provide input for specific planning of pilot areas in ZEN, more specifically Sluppen in Trondheim<sup>1</sup> (parallel assignments), Bodø vest<sup>2</sup> (district master plan) and Fornebu in Bærum<sup>3</sup> (district master plan). At the request of Bodø municipality, ZEN-SMS has now carried out an analysis of the proposals received in the parallel assignment for New city – new airport.

network; the street network's «degree of intersection density»; density of dwellings / residents and of workplaces; composition / distribution of dwellings / residents versus jobs; accessibility to public transport; share of public space and accessibility to green space and to the sea. The analyses do not assess the concepts but reveal some basic aspects of the received proposals for specific urban form. These aspects are crucial for urban qualities and sustainable mobility and which are largely determined in the early planning phase.

The analyses reveal major differences between the three plan proposals. While one proposal creates clear continuity and integration between the new district and the existing city and will probably strengthen the existing city center, another proposal does almost the opposite and will probably result in a new city center separated from the existing city center. The analyses also show interesting differences in terms of the number of homes / residents and workplaces within walking distance, which is of great importance for the potential for local service in an area. The design of the street network will be a decisive factor in the further planning. This applies to both the overall street network structure and design in more detail. In each case, it is important to reduce barrier effects, which in practice means establishing a coherent street network rather than individual continuous road facilities. Another important issue is to ensure that the potential of good overall plans is utilized and not weakened in further detail with regulations and building plans.

The goal for New city – new airport is to establish a compact city with good connections between existing and new districts, adapted for pedestrians, cyclists and public transport and with short distances between home, work, school and other daily destinations.

The analyses were carried out by first establishing a detailed GIS model of the existing Bodø area, and then adding the three plan proposals for New city – new airport into the same model. Then, eight different analyses were conducted for the three plan proposals, more specifically: accessibility / continuity in the street

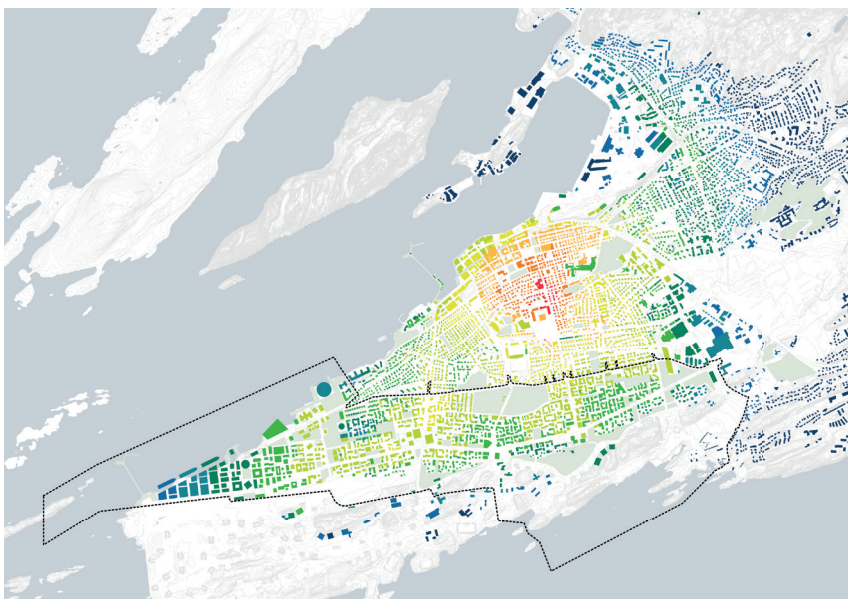

**Figure.** Population density measured as residents and workplaces within 1km walking distance. Bodø with proposal for New city – new airport.

# Evaluering av planforslag for Ny by – ny flyplass i Bodø

Ny by – ny flyplass skal bli en kompakt by med gode koblinger mellom eksisterende og nye bydeler, tilrettelagt for fotgjengere, syklister og kollektivtransport og med korte avstander mellom hjem, jobb, skole og andre daglige gjøremål. FME ZEN har vurdert ulike planforslag opp mot denne målsettingen.

Forskningsgruppen ZEN-SMS (Spatial Morphology Studies in ZEN) har utviklet analyseverktøy basert på GIS (geografisk informasjonssystem) for å måle og evaluere egenskaper ved byform som påvirker steds kvalitet og muligheter for bærekraftig mobilitet. På forespørsel fra Bodø kommune har ZEN-SMS nå evaluert innkomne forslag i parallelloppdraget for Ny by – ny flyplass.

Vi har først etablert en detaljert GIS-modell av dagens Bodø, og deretter lagt inn de ulike planforslagene for Ny by – ny flyplass i samme modell. I neste steg har vi analysert forskjellige egenskaper ved planforslagene, nærmere bestemt tilgjengelighet, kontinuitet og tetthet i gatenettet, tetthet av boliger/beboere og av arbeidsplasser, fordeling av boliger/beboere versus arbeidsplasser, tilgjengelighet til kollektivtransport, andel offentlig areal og tilgjengelighet til grøntareal og til sjøen. Dette er steds kvaliteter som i stor grad bestemmes i tidlig planfase.

Analysene avdekker store forskjeller mellom planforslagene. Mens ett forslag tydelig integrerer den nye bydelen med eksisterende by og antagelig vil styrke eksisterende bysentrum, gjør et annet forslag nesten det motsatte og vil antagelig resultere i ny sentrumsdannelse adskilt fra eksisterende sentrum. Analysene viser også interessante forskjeller når det gjelder antall boliger/beboere og arbeidsplasser innen gangavstand, noe som har stor betydning for potensialet for lokale tjenester i et område.

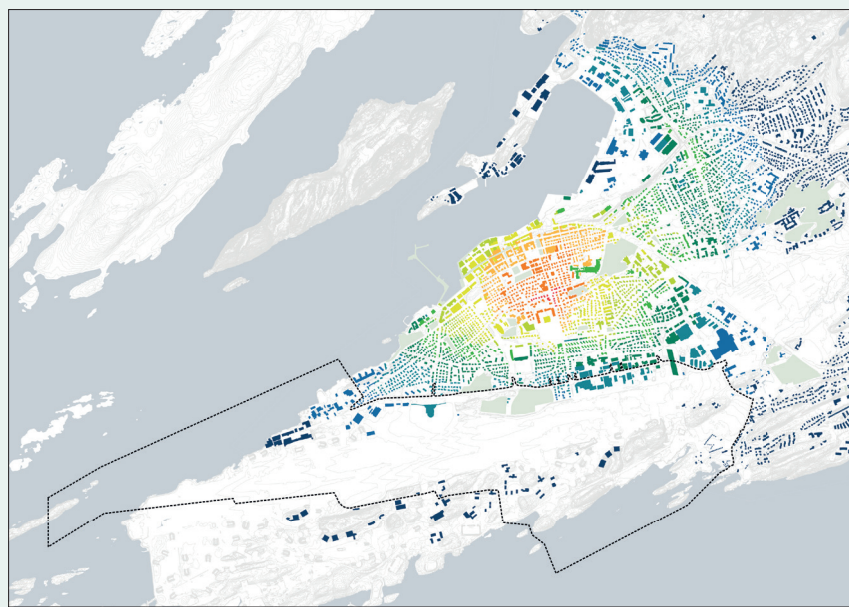

**Figur.** Befolkningstetthet målt som beboere og arbeidsplasser innen 1km gangavstand. Bodø, dagens situasjon.

Utforming av gatenettet, både overordnet struktur og detaljert utforming, vil være avgjørende for videre planlegging. For å unngå barrierer mellom områder som ønskes utviklet som sammenhengende by, er det viktig å etablere sammenhengende gatenett heller enn enkeltstående gjennomgående veianlegg. Det blir også viktig å sikre at gode overordnede planer ikke svekkes i videre detaljering med reguleringer og bebyggelsesplaner.

## Referanser

1. Nordström, T., Rokseth, L., Green, S. & Manum, B. ZEN SPATIAL INDICATORS Evaluation of parallel assignments for Sluppen. ZEN MEMO No. 20. SINTEF akademisk forlag 2020 29 s. NTNU
2. Nordström, T., Rokseth, L., Green, S. & Manum, B. ZEN SPATIAL INDICATORS Evaluation of Bodø west. ZEN MEMO No. 19. SINTEF akademisk forlag 2020 36 s NTNU
3. Nordström, T., Rokseth, L., Green, S. & Manum, B. ZEN SPATIAL INDICATORS Evaluation of Kommunedelplan 3 (KDP 3) for Fornebu. ZEN MEMO No. 21. SINTEF akademisk forlag 2020 60 s. NTNU

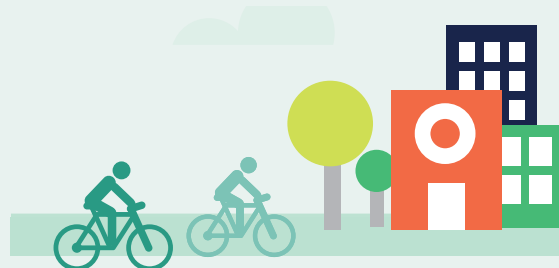

# Opportunities and limitations for additional floors in wood to existing apartment blocks



**Anne G. Lien**  
Senior Research Scientist  
SINTEF Community



**Rune Abrahamsen**  
CEO  
Moelven



**Gunhild Solem Eidsvik**  
City planner  
Gottlieb Paludan Architects

**Owners of apartment blocks built in concrete with three, four or five floors without an elevator, can sell the roof to new apartments and get an elevator partly financed.**

Areas with large demands for new housing can achieve sustainable densification with a low climate footprint. However, there are some drawbacks and limitations as well. Additions to apartment blocks will be stressful for the residents during the construction period. Densification in older residential areas which are attractive because their density/vibrancy is much lower than in newer areas, is unpopular. But older residential areas can often, in principle, not tolerate taller houses which increase shadows and place more demands on shared public space.

These findings are based on a case study in ZEN. Here, opportunities for extensions with modules are studied because this is a construction method with a short construction time on-site which will be the least invasive for residents. Issues related to the load bearing system and fire protection have been discussed but will require

more detailed knowledge. Costs and profitability must also be calculated to be able to read which types of projects will be feasible, but this was not prioritized in this project due to limited time and resources. Alongside this, Gottlieb Paludan Architects have developed a checklist for spatial qualities when adding dwellings to the relevant apartment blocks. This Checklist highlights which qualities must be ensured for extensions to be a positive contribution in a residential area. Researchers at the research centre ZEN have assessed the climate footprint of two alternatives, namely the increased span from extensions constructed in materials with low emissions, and also the case of demolition and new construction.

Renovation of older apartment blocks has many advantages. However, those

who live on the first floor miss the benefit from having an elevator installed. Those who live on the top floor before the extension, can be disadvantaged by the building above them. The most important question for the residents is perhaps: How does the project affect the market price for the existing apartments? It is probably positive for the upper apartments that need a lift and positive in terms of upgraded standard, but negative in terms of increased density in the area and increased rent.

Further work is needed, in particular case studies of good model projects to gain knowledge about the load-bearing capacity of apartment blocks, fire protection, costs, decision-making processes in the housing associations and other important issues that needs to be resolved.



**Figure.** The illustration is made for the project Circular economy - Wood industry concepts for upgrading and extension of existing buildings (end Febr 2021) (Norwegian Wood Industry association) and shows extensions with new apartments, common area and terrace, and elevator to each floor.



# Muligheter og begrensninger ved påbygg med tremoduler på eksisterende boligblokker

Eiere av boligblokker bygget i betong med tre, fire eller fem etasjer uten heis, kan selge taket til bygging av nye leiligheter og få delvis finansiering til heis.

Områder med stort behov for nye boliger kan dermed få en bærekraftig fortetting med lavt klimafotavtrykk. Det er imidlertid også ulemper og begrensninger ved slike løsninger. Påbygg på boligblokker vil være belastende for beboerne i byggeperioden. Fortetting i boligområder som er attraktive fordi tettheten i utgangspunktet er lav, er ikke populært. Ulempen er at høyere hus gir mer skygge og større belastning på utearealene.

I dette ZEN-caset beskriver Moelven muligheter for påbygg med moduler fordi det gir kort byggetid og er skånsomt for beboere. Problemstillinger knyttet til bæresystem og brannsikring er diskutert, men disse problemstillingene krever mer detaljert kunnskap. Kostnader og lønnsomhet gjenstår å beregne for å kunne vurdere hvilke typer prosjekter som vil være gjennomførbare. Arkitekter fra Gottlieb Paludan Architects har utviklet en sjekklister for stedsqualiteter ved påbygg av boliger på eksisterende boligblokker. Listen viser hvilke kvaliteter som må sikres for at påbygg skal bli et positivt tilskudd for et eksisterende boligområde. Forskere fra FME ZEN har vurdert klimafotavtrykket og sammenliknet utslipp fra påbygg med materialer med lavt utslipp og rivning og nybygg.

Renovering av eldre boligblokker har mange fordeler, men de som bor i 1. etasje har ingen nytte av at heis installeres. De som har toppetasjen før påbygg, kan synes det er en ulempe å få nye leiligheter over seg. Det viktigste spørsmålet for beboerne er kanskje: Hvordan

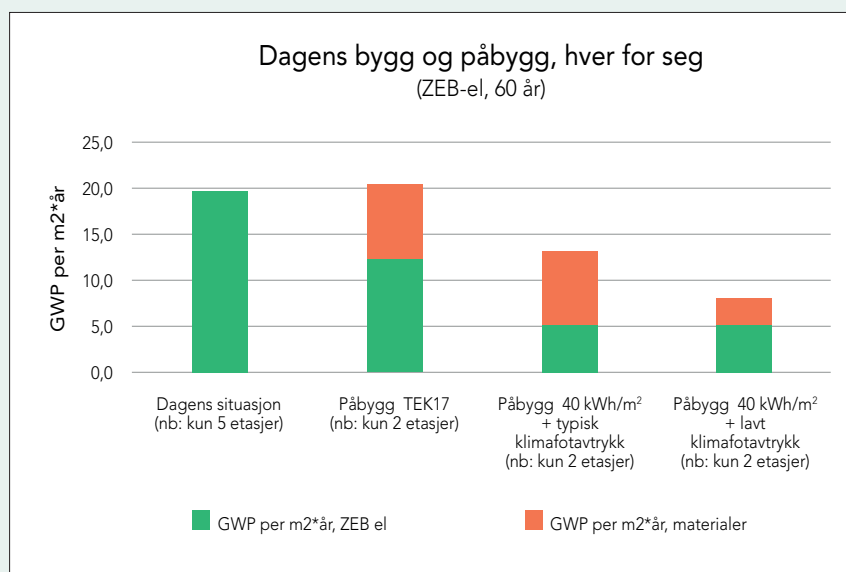

**Figur.** Figuren viser klimafotavtrykket per m² og år for dagens situasjon (en blokk med 5 etasjer) sammenliknet med tre alternative påbygg (2 etasjer). Resultatene viser at et påbygg i henhold til TEK17 vil ha et klimafotavtrykk omtrent tilsvarende den eksisterende boligblokken, mens et påbygg med høy klimaambisjon og høy energiambisjon vil ha omtrent det halve. Kilde: Skaar i Lien et al. 2020 Fortetting med påbygg i tre, ZEN Memo No. 32 2020.

påvirker prosjektet markedsprisen for de eksisterende leilighetene? Det er sannsynligvis positivt for de øverste leilighetene som har behov for heis og positivt med tanke på oppgradert standard, men negativt i forhold til økt tetthet i området og økt husleie.

Det er behov for å se nærmere på gode forbildeprosjekter for å få kunnskap om boligblokkenes bæreevne, brannsikring, kostnader, prosesser for beslutning i borettslagene og andre viktige spørsmål som fortsatt er uløst.



# Model predictive control of heating systems for utilization of building flexibility



**Harald Taxt Walnum**  
Research Scientist  
SINTEF Community



**Igor Sartori**  
Senior Research Scientist  
SINTEF Community

**Results from simulations show a potential to shift 50-90 % of heating energy consumption away from peak hours, while keeping a good indoor climate.**

Utilization of the flexibility potential in building stock can contribute to increased capacity and more efficient operation for both electricity and the district heating grid, and hence lower emission and investments. A significant part of the potential is derived from a buildings thermal mass. Many existing buildings today have minimal or no control of their heating system. At the same time these buildings represent a large share

of the flexibility potential. Current work therefore focuses on how to release the flexibility potential in a cost-efficient way.

A simulation environment has been developed to evaluate the flexibility potential for buildings. The model allows for coupling of detailed building models (Emulator) with external control algorithms. This then in turn enables an evaluation of the flexibility potential of a building and for a comparison to be conducted of different control algorithms.

An algorithm has been developed of a building substation based on the Model Predictive Control (MPC) concept. The concept is founded on optimization of operation for time periods of 24-48 hours for the control model, predictions of user behaviour, weather and energy prices (and other external control signals have been factored into the model). The optimization is updated at each control step (typically one hour) with measurements from the building/emulator, to ensure stable control.

This enables the building to respond to external control signals, e.g. from the grid operator, and thereby supply flexibility as a service. Results from simulations show a potential to shift 50-90 % of heating energy consumption away from peak hours, while keeping a good indoor climate.

The concept is planned for demonstration at SINTEF Communities own premises in Oslo, in Børrestuveien 3. To raise further funding for this project, the building is part of a new EU-proposal as a demonstration site. ZEN partners GK and Fortum Oslo Varme are both involved in the application and the work related to the demonstration as BMS supplier (GK-Cloud) and district heating company, respectively.

The developed framework and results show a significant potential for flexibility and will be further utilized both for flexibility potential evaluation and testing for control concepts.

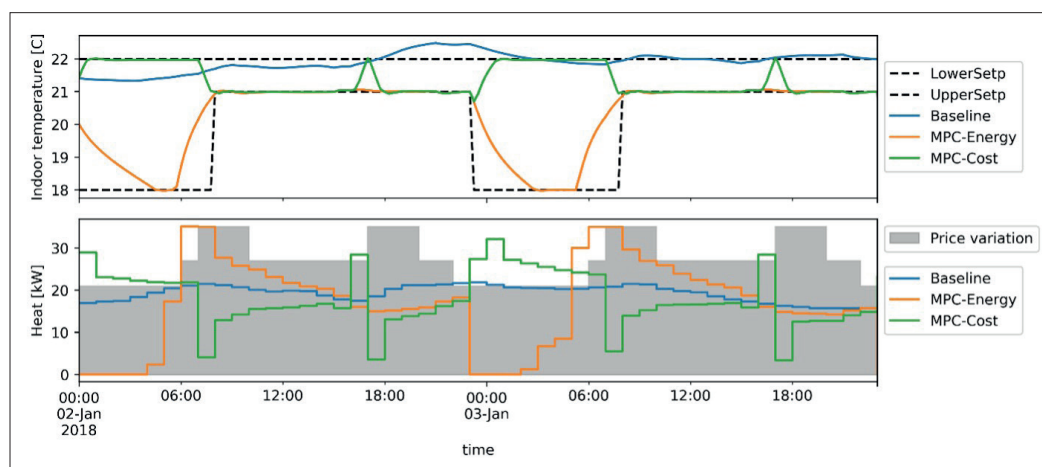

**Figure.** Example on how buildings can respond to external signal by modifying the indoor air temperature.



# Prediktiv styring av oppvarmingsystemer for utnyttelse av fleksibilitet

Resultater fra simulering viser at det er mulig å flytte 50-90 % av byggets energibruk til oppvarming fra topplast-timene, til andre timer på døgnet, samtidig som man opprettholder et godt inneklima.

En stor del av bygningsmassens fleksibilitetspotensial inn mot energisystemet ligger i muligheten for å flytte energibruk i tid. Med riktig styring kan fleksibiliteten i bygningsmassen utnyttes for bedre drift av elektrisitets- og fjernvarmenettet, og dermed gi lavere kostnader og utslipp. Et av de største potensialene ligger i den termiske massen til bygg.

Ved riktig styring av energibruken er det mulig å flytte store laster i tid, slik at man kan avlaste nettet. Mange gamle bygg har i dag enkel eller ingen styring av varmesystemet, samtidig representerer disse byggene et stort potensial for fleksibilitet i energiforsyningen. I FME ZEN ser vi på hvordan eksisterende bygg kan bli fleksible på en konstandseffektiv måte.

For å evaluere potensialet for å spre energibruken er det utviklet et simuleringsoppsett, der man kan koble en detaljert modell av bygget (Emulator) – både av bygningskropp og klimaanlegg – med eksterne kontrollalgoritmer. Slik kan vi både evaluere fleksibilitetspotensialet og teste og sammenlikne ulike kontrollalgoritmer.

Det er utviklet en algoritme for styring av kundesentraler basert på Model Predictive Control (MPC). Dette er et konsept som baserer seg på at en forenklet modell av bygget, en styringsmodell, som er egnet for bruk i sanntid, sammen med prediksjoner for fremtidig bruk, vær og pris (eller andre styringssignaler) brukes

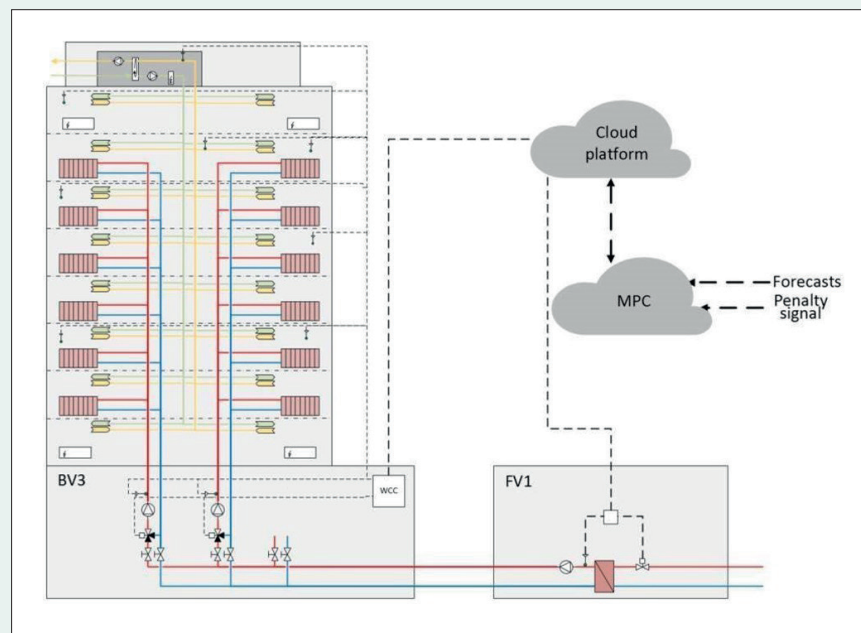

Figur. Prinsipp for tilkobling av MPC til byggets SD-anlegg for overstyring av radiatorkurser.

til å optimere driften for de neste 24-48 timer. Styringsmodellen oppdateres hver time med målinger fra bygningen/Emulatoren slik at den optimale driften stadig justeres. Dette gjør det mulig for bygget å respondere på eksterne signaler fra for eksempel fjernvarmeleverandøren, og dermed levere fleksibilitet som en tjeneste.

Konseptet er planlagt for implementering og testing på SINTEF Communitys eget bygg i Oslo, i Børrestuveien 3. For å innhente ekstra midler til dette er bygget med som demo i en EU-søknad. ZEN-partnerne GK og Fortum Oslo Varme er involvert i søknaden og arbeidet på demonstrasjonen gjennom å være henholdsvis leverandør av SD-anlegg

(GK-Cloud) og fjernvarme til bygget.

Det utviklede rammeverket og resultatene viser et betydelig potensial for fleksibilitet og vil brukes videre både for evaluering av fleksibilitetspotensial og testing av mulige styringskonsepter.

## Referanse

Walnum, Harald Taxt., Sartori, Igor., Bagle, Marius., 2020, Model predictive control of District Heating substations for flexible heating of buildings. Build-Sim Nordic 2020. Book of Abstracts. International Conference Organized by IBPSA-Nordic 13th-14th October 2020, Oslo ISBN: 978-82-8364-267-4. Available from: <https://fagarkivet.oslomet.no/handle/20.500.12199/6424>

# How zero-emission areas in Norway affect the European power market



**Stian Backe**  
PhD Candidate  
NTNU

Reducing the electricity need in Norwegian buildings is a valuable contribution on the transition towards an emission-free European power system.

More heat pumps producing heat with less electricity is a key measure to lower electricity consumption in Norwegian buildings. Additionally, more incineration of biomass and waste to heat Norwegian buildings lower their electricity need. When Norwegian buildings use less electricity, less wind power is demanded and the costs of achieving European emission targets are reduced.

The above are the findings from the EMPIRE model simulation, where investments minimize total costs when decarbonizing the European power system. EMPIRE's strength is the simultaneous representation of hour-by-hour operation and multi-year investments. Through FME ZEN, EMPIRE has been developed to represent building heating and charging of electric transport, to better represent energy solutions in ZEN.

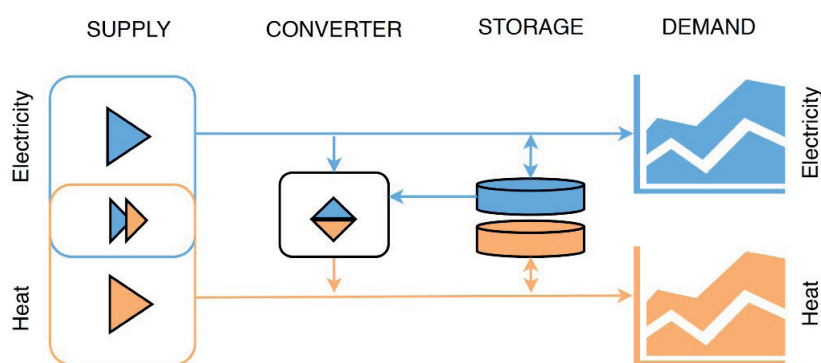

**Figure.** Illustration of the multi-carrier operations in EMPIRE. There are two parallel markets (building heat and electric-specific) that are cleared on an hourly basis.

Half of Norwegian electricity use comes from buildings, and 40% of European electricity production is fossil. European climate targets demand the elimination of emissions from electricity production within 20-30 years. EMPIRE shows that this is feasible with emission quotas through renewable energy investments and increased transmission between countries. Over 90% of Norwegian electricity production is renewable hydropower, and regulated hydropower is rare and valuable in a renewable Europe. EMPIRE reveals that Norwegian buildings using less electricity increase Norway's hydropower export, which makes it easier for Europe to decarbonize.

In ZEN, the goal is to develop a neighborhood that contributes to net zero greenhouse gas emissions over its lifetime.

EMPIRE shows that renewable electricity production in ZEN does not yield avoided emissions in the power system when emission quotas are fixed. The premise for avoided emissions through renewable electricity generation in ZEN is that the electricity production replaces production with higher emissions elsewhere. However, EMPIRE shows that the replaced electricity production is renewable rather than fossil, which happens because the power system dominated by variable renewables has very high value of dispatchable electricity production.

Energy solutions in ZEN affect the power system, and changes in the power system affect ZEN. The transition towards the zero-emission society will be most effective when ZEN and the larger power system coordinates.

## Referanser

Backe, Stian, Magnus Korpås, and Asgeir Tomasgard. "Heat and electric vehicle flexibility in the European power system: A case study of Norwegian energy communities." *International Journal of Electrical Power & Energy Systems* 125: 106479. <https://doi.org/10.1016/j.ijepes.2020.106479>



# Slik påvirker nullutslippsområder i Norge det europeiske kraftmarkedet

**Når norske bygg bruker mindre strøm, blir det enklere å fase ut fossil kraftproduksjon i Europa.**

Energiløsninger i nullutslippsområder påvirker kraftsystemet, og endringer i kraftsystemet påvirker nullutslippsområder. Overgangen til nullutslippssamfunnet krever store endringer som enklere gjennomføres når nullutslippsområder spiller på lag med det øvrige kraftsystemet.

Det er først og fremst økt bruk av varmepumper, som produserer varme for mindre strøm, som kan redusere strømforbruket i norske bygg. Også økt forbrenning av avfall og biomasse til oppvarming reduserer strømbruket. Det viser beregninger fra modellen EMPIRE, som simulerer hvordan ulike investeringer



påvirker utslippene og lønnsomheten i det europeiske kraftsystemet. Styrken til modellen ligger i å både representere kraftsystemets drift time-for-time og samtidig representere flerårige investeringshorisonter. I FME ZEN er EMPIRE videreutviklet til å simulere varmebruk i bygg samt ladning av elektriske kjøretøy. Slik gir modellen et bedre bilde av energiløsninger i nullutslippsområder.

Bygg står for omtrent halvparten av det norske strømforbruket. Samtidig kommer 40% av dagens Europeiske strømproduksjon fra fossile kilder. Klimamål tilsier at disse utslippene skal elimineres innen 20-30 år, og EMPIRE viser at dette gjøres kostnadseffektivt med et kvotemarked gjennom massive investeringer i fornybar energi og økt kraftutveksling mellom landegrensene. Mer enn 90% av strømproduksjonen i Norge er fornybar vannkraft, og regulerbar vannkraft er både sjelden og verdifull i et Europa som når klimamålene. EMPIRE viser at bygg som bruker mindre strøm i Norge, gjør norsk vannkraft mer tilgjengelig i Europa, noe som igjen bidrar til at europeiske klimamål blir enklere å oppnå.

Et nullutslippsområde er et nabolag som bidrar til netto null klimagassutslipp gjennom sin levetid. EMPIRE viser imidlertid at fornybar strømproduksjon i et nabolag ikke unngår utslipp i kraftsystemet når utslippene er politisk regulert. Forutsetningen for å unngå utslipp gjennom fornybar strømproduksjon i nullutslippsområder er at strømproduksjonen i nabolaget erstatter annen strømproduksjon med mer utslipp. EMPIRE viser derimot at strømproduksjonen i nabolaget erstatter annen fornybar energi fremfor fossil energi. Dette skjer fordi vi sammenligner med en situasjon der Europa når klimamålene og fjerner godt over 90% av utslippene fra kraftproduksjon. Da reduseres ikke de totale klimautslippene ved å bruke lokal fornybar energi.

## Referanser

Backe, Stian, Magnus Korpås, and Asgeir Tomasgard. "Heat and electric vehicle flexibility in the European power system: A case study of Norwegian energy communities." *International Journal of Electrical Power & Energy Systems* 125: 106479. <https://doi.org/10.1016/j.ijepes.2020.106479>

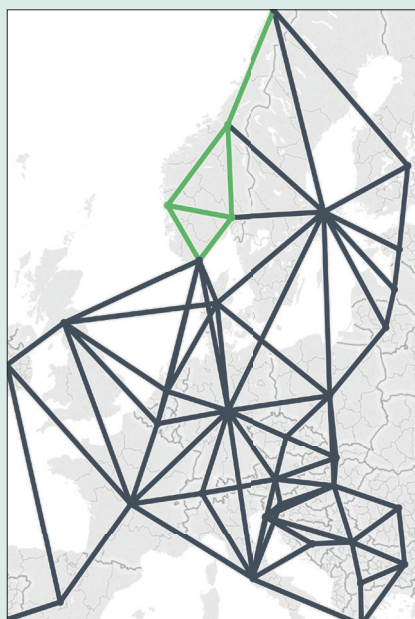

**Figur.** Illustrasjon av kraftsystemmodellen EMPIRE. Nodene representerer kraftmarkeder, mens linjene representerer mulighetene for kraftutveksling mellom markedene.

# Ydalir living lab: The good life



**Ruth Woods**  
Research Scientist  
NTNU



**Thomas Berker**  
Professor  
NTNU



**Anna-Thekla Tonjer**  
Prosjektleder  
Elverum Vekst



**Kate Langsethagen**  
Rådgiver  
Elverum Vekst

they think about sustainability. This is being done by collecting stories about the “good life” from “Elverumsinger”; with contributions from people of all ages and cultural backgrounds. The good life is a broad concept and encourages all kinds of stories about what it is like to live in Elverum; experiences from World War II, the forest, trade and industry, café culture, handicrafts, going to school and local architecture.

Ydalir living lab operates in close collaboration with Elverum Vekst, Ydalir school and kindergarten. Using photo documentation, we have gathered insight from local children about why they think Elverum is a good place to live, and the slow process of gathering stories has begun. By locating the living lab in the library, in the offices of Elverum Vekst, and

a local shopping centre we are making Ydalir living lab available to anyone who feels that they have a story to tell.

Talking to people is necessary: to parents, building users, workers, the elderly, the single, children, and teenagers. We are equally interested in people who were raised in the town and those who have relocated there later in life. It is important to know about the every-day lives of those living in Elverum to be able to connect ZEN's future solutions to people's lives. For Ydalir, it is important to find out how the “good life” is experienced today to ensure that both the environment and the quality of life are ensured. In this way, Ydalir living lab is working towards making good living environments and sustainable neighbourhoods two sides of the same thing.

**The desire to bring the sustainable future closer to people's everyday lives is a central part of the ZEN vision. By designing and building sustainable neighbourhoods, ZEN expects to make it easier to live more sustainably.**

The Ydalir neighbourhood in Elverum has broad political support with ambitions that are mostly supported by the local population and construction industry. However, as with anything new, there exist some reservations about the project.

Ydalir living lab is designed to understand the reservations of different user groups, but rather than focusing on the uncertainties, we have asked what the good life is in Elverum today, and is a sustainable future far ahead of us or is it connected to how we live today?

To find answers, we need to know more about people's everyday lives and what



**Figure.** Ydalir kindergarten picking blueberries. Photo: Linda Vespestad, Elverum municipality.

# Ydalir living lab: Det gode liv



Figur. 7. trinn ved Ydalir skole som har vært med på fotodokumentasjonsprosjekt. Foto: Linda Vespestad, Elverum kommune

**Sentralt i visjonen til ZEN er et ønske om å bringe en bærekraftig fremtid nærmere folks hverdag. ZEN vil gjøre det lettere å leve mer bærekraftig gjennom å designe og bygge bærekraftige nabolag.**

Ydalir-området i Elverum har bred støtte både hos politikere, innbyggere og byggenæringen. Men som med alt nytt, finnes det noes usikkerhet og skepsis til prosjektet.

Ydalir living lab er designet for å forstå utfordringene og usikkerheten. Men i stedet for å sette søkelys på det spør vi lokalbefolkning hva er det gode liv i Elverum? Og om en bærekraftig fremtid ligger langt foran oss? Eller er det

kanskje tettere knyttet til hvordan vi lever i dag?

For å finne svar, må vi vite mer om hverdagene til folk i Elverum og hva de mener om bærekraft. Vi gjør dette gjennom å samle historier fra "Elverumsinger" om det gode liv; fra mennesker i alle aldre og kulturell bakgrunn. Det gode liv er et bredt konsept som oppmuntrer til historier om hvordan det er å bo i Elverum, opplevelser fra andre verdenskrig, å være i skogen, handel og industri, kafékultur, håndverk, skolegang og lokal arkitektur.

Ydalir living lab er et samarbeid med Elverum Vekst, Ydalir skole og barnehage. Vi har blant annet brukt fotodokumentasjon til å samle meninger og tanker fra barn om hva de synes er bra med å bo i Elverum og vi er i gang med

å samle historier fra andre. Vi har lagt opp til at folk kan fortelle sine historier til oss på biblioteket, kontorene til Elverum Vekst og i et lokalt kjøpesenter. Dermed blir Living lab gradvis tilgjengelig for alle som har lyst til å fortelle sin historie.

Det er helt nødvendig å snakke med alle typer folk - foreldre, arbeidere, eldre, enslige, barn og tenåringer. Mennesker som er født og oppvokst i byen og de som har flyttet til Elverum – vi trenger å vite mer om hvordan Elverumsinger lever sine liv for å kunne koble ZENs bærekraftige løsninger til hverdagen deres. For Ydalir er det viktig å finne ut hva det gode livet er for å sikre at både miljøet og livskvaliteten blir ivaretatt. Ydalir living lab jobber for å tydeliggjøre at gode bomiljøer og bærekraftige nabolag kan være to sider av samme sak.

# Can demand controlled ventilation (DCV) with heat recovery achieve dual centred victory (DCV)?



**Peng Liu**  
Research Scientist  
SINTEF Community



**Hans Martin Mathisen**  
Professor  
NTNU



**Håvard Bergsdal**  
Senior Research Scientist  
SINTEF Community

**Buildings become highly insulated and airtight with stringent requirements on the energy performance of the building envelope. Ventilating these better sealed buildings is essential to ensure indoor air quality (IAQ) as an imperative public health aspect, which has its social and economic consequences.**

On the other hand, heating and pumping the ventilation air is an energy intensive process. In energy efficient buildings, ventilation often accounts for a prevail-

ing share among total energy required by heating, ventilation and air conditioning (HVAC).

Demand controlled ventilation (DCV) with heat recovery is identified as a superior technology to reduce energy use and thus mitigate greenhouse gas emission without compromising IAQ. DCV adjusts airflow rates to continuously match the actual demand characterised by IAQ and/or thermal comfort. During most of the operating time, DCV runs at reduced airflow rates leading to energy savings by handling less ventilation air. The varying reduced airflow rates in DCV are in relation to the temperature efficiency of heat recovery.

Recent findings on heat wheels, one of the widely adopted heat recoveries, reveals that the temperature efficiency decreases considerably with reduced airflow rates. The maximum temperature efficiency tends to be limited to around 80 %, which is then only achieved in the rare cases where DCV requires a lot of air. This means that the energy saving potential in DCV may have been overestimated. This study is developing a calculation model for more realistic annual ventilation ener-

gy use in DCV. The design of heat wheels for DCV is optimised to yield yearly maximum energy savings considering heat recovery amount and fan power.

There is a trade-off between operating energy and material use in DCV. Larger dimensions of DCV with more material use results in lower air velocity and thus less fan power demand [1]. This work is studying the environmental impacts of DCV systems with Life Cycle Assessment (LCA). The results of the more realistic energy use of DCV become input parameters together with the material use for the LCA. Multi-objective optimisation with developed models to minimise DCV energy use and environmental impacts, which refer to Double Centred Victory, is expected to answer the question “Can Demand Controlled Ventilation (DCV) with Heat Recovery Achieve Dual Centred Victory (DCV)?”

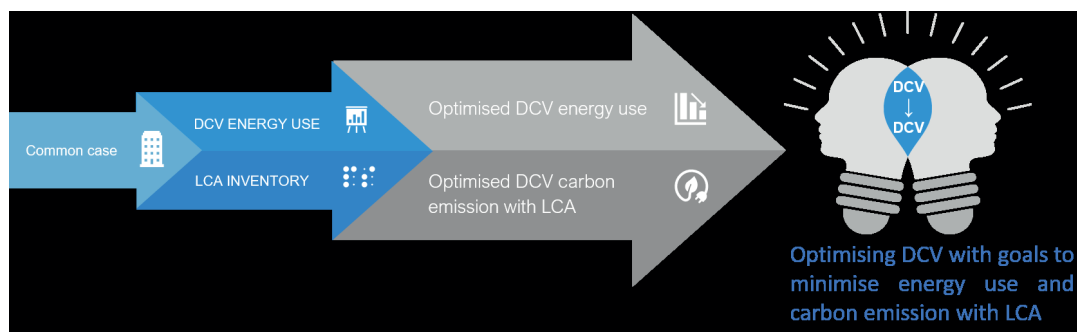

**Figure.** Workflow of optimising demand controlled ventilation with goals to minimise energy use and carbon emission.



# Bedre design av behovsstyrt ventilasjon og varmegjenvinning med livsløpsanalyse?

Vår tids strenge krav til energiytelser i bygningssektoren fører til meget godt isolerte og lufttette bygninger. Å ha god ventilasjon i disse godt forseglede bygningene er viktig for å sikre god inneluftkvalitet.

Inneklimate er et viktig folkehelseaspekt som har sine sosiale og økonomiske konsekvenser. På den annen side er oppvarming og transport av ventilasjonsluft en energiintensiv prosess. I energieffektive bygninger utgjør ofte ventilasjon en vesentlig andel av den totale energien som kreves for klimatisering.

Behovsstyrt ventilasjon med varmegjenvinning er ubestridelig en overlegen teknologi for å redusere energibruken og dermed redusere klimagassutslipp uten å kompromittere luftkvaliteten. Den behovsstyrte ventilasjonen justerer luftmengden slik at den kontinuerlig

samsvarer med det faktiske behovet, bestemt av luftkvaliteten og/eller termisk komfort. I det meste av driftstiden opererer behovsstyringen med reduserte luftmengder som fører til energibesparelser fordi det håndteres mindre ventilasjonsluftmengder. De varierende og reduserte luftmengdene ved behovsstyring har imidlertid en sammenheng med temperatureffektiviteten til varmegjenvinningen.

Nylige funn avslører at temperatureffektiviteten til roterende varmevekslere, som er en av de mest brukte varmegjenvinnerteknologiene, synker betydelig med reduserte luftmengder. Maksimal temperatureffektivitet har en tendens til å være begrenset til rundt 80 %, noe som da bare oppnås i de sjeldne tilfellene hvor behovsstyringen ber om mye luft. Det betyr at energisparepotensialet i DCV kan ha blitt overvurdert. Det pågående arbeidet

utvikler en beregningsmodell for mer realistisk årlig ventilasjonsenergi bruk ved behovsstyrt ventilasjon. Utformingen av den roterende varmeveksleren for behovsstyring blir optimalisert for å gi maksimale årlige energibesparelser med tanke på varmegjenvinningsmengde og vifteeffekt.

Det oppstår en avveining mellom energi til drift og materialbruk. Større dimensjoner gir lavere lufthastighet og dermed mindre energibehov til drift av vifter. Til gjengjeld øker materialbruken til komponentene. Resultatene av en mer realistisk energibruk for den behovsstyrte ventilasjonen sammen med materialbruken blir inngangsparametere for en livssyklusanalyse (LCA). Multi-objektiv optimalisering med kriterier for å minimere DCV energibruk og miljøpåvirkning forventes til slutt å svare på spørsmålet "Bedre design av behovsstyrt ventilasjon og varmegjenvinning med livsløpsanalyse?"

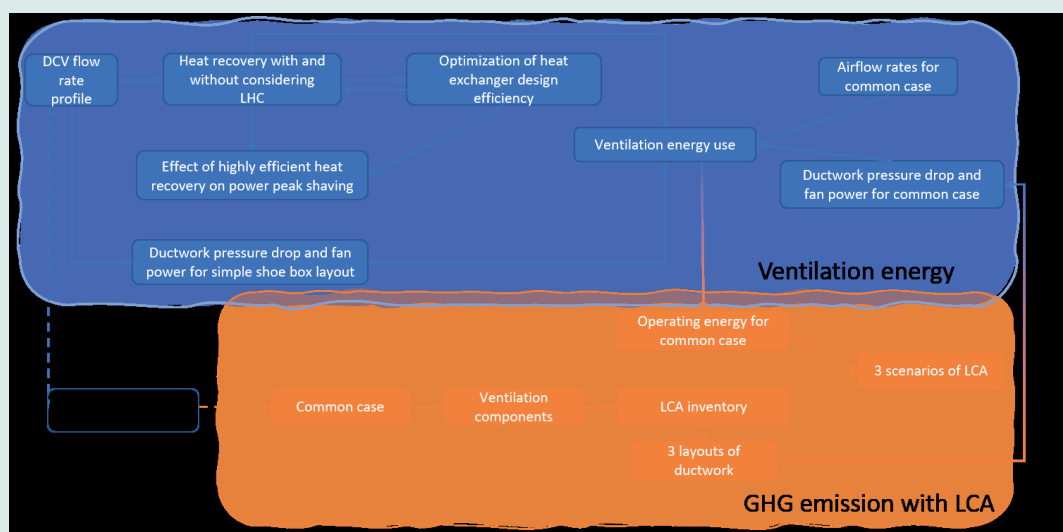

Figur. Modellering av energibruk og karbonutslipp for system med varmegjenvinning og behovsstyrt ventilasjon

# Energy system optimization for everyone – here comes the web-based version of eTransport



**Magnus Askeland**  
Research Scientist,  
PhD Candidate  
SINTEF Energy and NTNU

**eTransport is a tool that can be used to plan development and operation of energy systems which builds advanced mathematical models based on a graphical user interface.**

The user specifies the current system, assumptions related to future development and investment options, and eTransport presents optimal investment strategies.

One challenge regarding eTransport has been that it has been relatively cumbersome for new users to get started since it requires underlying optimization tools to be installed and correctly configured at the user's computer. Since eTransport is supposed to be a user-friendly tool that does not require advanced knowledge of the underlying methods, we decided to improve this aspect.

To make eTransport more user-friendly, SINTEF researchers have cooperated with external expertise on functionality in Sharepoint to develop a cloud-based solution that is significantly simpler to use. From the user's point of view, only Micro-

soft Visio is required to get started with eTransport, and the rest is handled at a SINTEF server.

Secure connection of external users to the SINTEF server has been a challenge, which has been solved since the solution exploits already established methods for interacting with external parties. The setup works by connecting the server and the users to a common cloud-based file structure through tailor-made routines. Even though the solution is based on relatively advanced architecture and tailor-made routines for the client-server interaction, the solution is easy to use from the user perspective. The solution has recently been put into operation after testing by SINTEF researchers, and now the plan is to deploy it to students and other interested parties.



Figure. Tools are being developed in ZEN.

# Et verktøy for energi-systemanalyser for alle – her kommer web-versjonen av eTransport

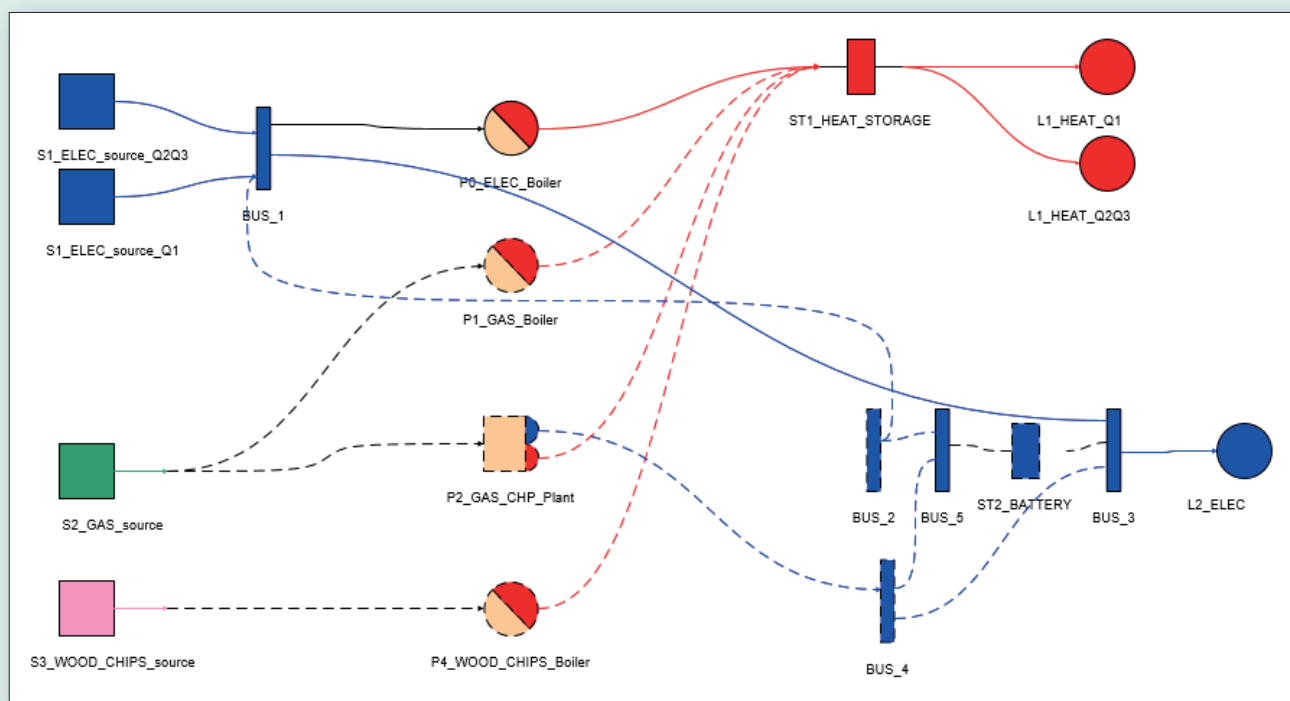

Figur. Eksempelsystem med flere energibærere i eTransport.

**eTransport er et verktøy for å planlegge utvikling og drift av energisystemer som er basert på at avanserte matematiske modeller blir bygget opp og optimert basert på et grafisk brukergrensesnitt.**

Brukeren spesifiserer dagens system, antagelser om fremtidig utvikling samt investerings-muligheter, og får presentert optimale investeringsstrategier. Nå har vi gjort analyseverktøyet enklere å bruke ved å ta i bruk skybaserte løsninger.

En utfordring med eTransport har vært at dette er tungvint å ta i bruk på grunn av behov for at underliggende optimerings-

verktøy er installert og konfigurert riktig hos brukeren. Da eTransport er ment å være et brukervennlig verktøy som ikke skal kreve at brukeren er kjent med de avanserte metodene som den bygger på så vi et behov for å gjøre dette enklere.

For å gjøre eTransport mer brukervennlig har SINTEF-forskere i samarbeid med ekstern ekspertise på Sharepoint-funksjonalitet utviklet en skybasert løsning som er langt enklere å forholde seg til fra et brukerperspektiv. Fra brukerens side er det nå kun produktet Microsoft Visio som må være installert på egen PC, resten håndteres på en SINTEF-server.

Sikker tilkobling av eksterne brukere mot SINTEFs server har vært en utfordring, og dette har nå blitt løst da løsningen bygger på allerede etablerte måter å samhandle med eksterne parter. Dette fungerer ved at serveren og brukeren er koblet opp mot samme skybaserte mappestruktur gjennom skreddersydde rutiner. Selv om denne løsningen bygger på en relativt avansert arkitektur samt skreddersydde rutiner for klient-server interaksjon, så er løsningen smidig for brukerne av eTransport. Løsningen har akkurat blitt satt i drift etter innledende testing av SINTEF-forskere, og nå er planen å ta den i bruk hos studenter og eksterne aktører som ønsker å prøve dette.

# Material embodied emissions from buildings in zero emission neighbourhoods



**Helge Brattebø**  
Professor  
NTNU



**Eirik Resch**  
PhD Candidate  
NTNU



**Eivind Selvig**  
Partner  
Civitas

**A study of new Norwegian buildings show that they have material embodied emissions around 5.4 kgCO<sub>2</sub>e/m<sup>2</sup>/year, as an average. This can serve as a reference for needed future emission reductions.**

FME ZEN develops knowledge on net zero emissions from neighborhoods. Emissions are caused by energy, materials and land use changes in a development project. To reach net zero, these emissions must be compensated by measures giving “negative emissions”. Such measures are reduced if emissions from construction, material use in buildings and outdoor structures, are minimized by material-efficient design and by selection of materials with low life-cycle emissions. Compensating measures include: the generation and export of excess renewable energy which replace more carbon-intensive energy elsewhere; reuse and materials recycling; and carbon storage in materials used in buildings and landscaping.

Emissions are quantified by life cycle assessment (LCA). The ZEN Centre has carried out several LCA-studies, and synthesized studies by others. Wiik et al. (2020) examined LCA-data from more than 130 building projects from 2009-2020, representing more than 1 million m<sup>2</sup> heated floor area, with focus on production (module A1-A3), replacement of materials during use (module B4), and statistical analysis. Results show an interquartile range of 4.0-8.2 kgCO<sub>2</sub>e/m<sup>2</sup>/year and a median of 5.4 kgCO<sub>2</sub>e/m<sup>2</sup>/year over a 60-year period for all building types. The report offers data for building elements, life cycle modules, building types and project phases (Figure p. 28).

Results can be used as a basis when developing requirements for material emissions in buildings, in building codes (TEK). The research also points to needed

emission reductions to comply with Norway’s policy target for 2030 and 2050. This is also developed further in a new calculation method for FutureBuilt ZERO (Figure p. 29), with contributions from ZEN partners FutureBuilt, AsplanViak and Civitas, and PhD-student Eirik Resch at NTNU.

It is important for FME ZEN that results are used in new FutureBuilt ZERO criteria, and that the new calculation method shall be explored and further developed by Statsbygg for NTNU’s Campus Gløshaugen. This method includes new elements not covered by NS3720 today, such as technology improvements for materials, carbon storage in concrete and wood, carbon compensation for potential reuse of building elements, and time weighting of future emissions.

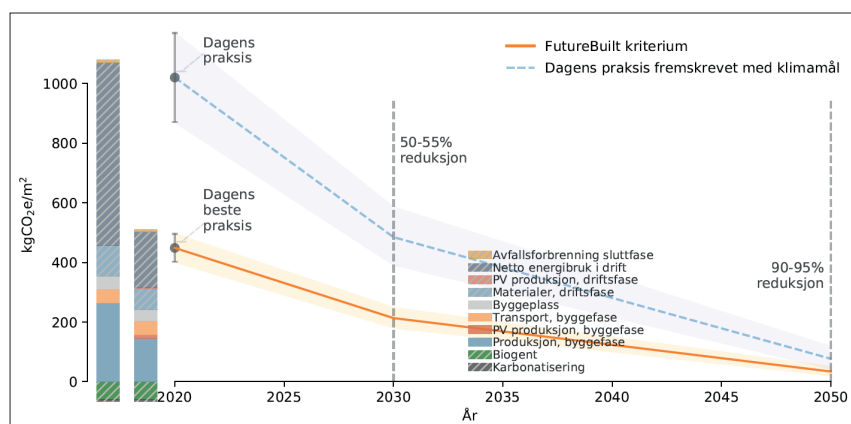

**Figure.** Greenhouse gas emissions for today’s best practice, with projections based on climate policy targets according to FutureBuilt ZERO criteria towards 2050 (Andresen et al. 2020)

# Materialrelaterte utslipp fra bygninger i nullutslippsområder

**FME ZEN utvikler kunnskap om netto null utslipp av klimagasser fra utbyggingssområder.**

En studie av nyere norske bygg viser at de i snitt har materialrelaterte utslipp av klimagasser på ca. 5,4 kgCO<sub>2</sub>e/m<sup>2</sup>/år, og kan være en referanseverdi for utslippsreduksjoner fremover.

Klimagassutslipp kommer av energibruk, framstilling og frakt av materialer og endret arealbruk. For å oppnå netto null utslipp må disse utslippene kompenseres med tiltak som gir tilsvarende store 'negative utslipp'. Kompenserende tiltak kan være lokal produksjon og eksport av fornybar energi utover det området selv forbruker, som kan erstatte mer karbonintensiv energi andre steder, ombruk og materialgjenvinning, og karbonlagring i materialer i bygningene og i utearealenes jordsmonn og vegetasjon.

For å begrense behovet for kompenserende tiltak og oppnå lav ressursbruk må utslipp fra byggefasen, materialbruk i

bygninger og uteområder, samt transport minimeres. Dette oppnås ved material-effektiv design og valg av materialer med lave klimagassutslipp over livsløpet.

Utslipp skjer i mange byggevarers verdikjeder, og estimeres ved livsløpsvurderinger (LCA). FME ZEN har utført flere LCA-studier for bygninger og nullutslippsområder, og sammenfattet studier utført av andre. Wiik et al. (2020) sammenfattet LCA-data fra over 130 byggeprosjekter, med fokus på utslipp fra produksjonsfasen (A1-A3), utskiftninger av materialer i bruksfasen (B4), og statistisk analyse av bygninger fra 2009-2020 som dekker over 1 million m<sup>2</sup> oppvarmet gulvareal. Resultatene over livsløpet på 60 år viser en kvartilbredde på 4,0-8,2 kgCO<sub>2</sub>e/m<sup>2</sup>/år og en median på 5,4 kgCO<sub>2</sub>e/m<sup>2</sup>/år for alle bygningstypene. Rapporten gir utslippsdata for bygningsdeler og livsløpsmoduler, og ulike bygningstyper og prosjektfaser (figur s. 28).

Resultatene kan brukes som grunnlag ved innføring av krav til materialrelaterte

utslipp fra bygg, f.eks. i teknisk forskrift (TEK) til plan- og bygningsloven. Arbeidet peker på nødvendige årlige kutt i utslipp for å oppnå Norges klimamål i 2030 og 2050. Dette er også behandlet videre i ny beregningsmetodikk for FutureBuilt ZERO (figur s. 29) med bidrag fra ZEN-partnerne FutureBuilt, AsplanViak og Civitas samt ZEN/NTNU-stipendiat Eirik Resch.

Det er viktig for FME ZEN at resultatene brukes som grunnlag for nye FutureBuilt ZERO-kriterier, og at de nye metodiske elementene skal utforskes og videreutvikles i Statsbyggs planlegging og gjennomføring av NTNUs Campus Gløshaugen.

## Referanser

Wiik, M.; Selvig, E.; Fuglseth, M.; Resch, E.; Lausset, C.; Andersen, I.; Brattebø, H.; Hahn, U. (2020): Klimagasskrav til materialbruk i bygninger. [ZEN Rapport Nr. 24](#), 2020.

Andresen, I.; Resch, E.; Wiik, M.; Selvig, E.; Stoknes, S. (2020): [Notat FutureBuilt ZERO – Kriterier, regneregler og dokumentasjonskrav](#). 14.08.2020

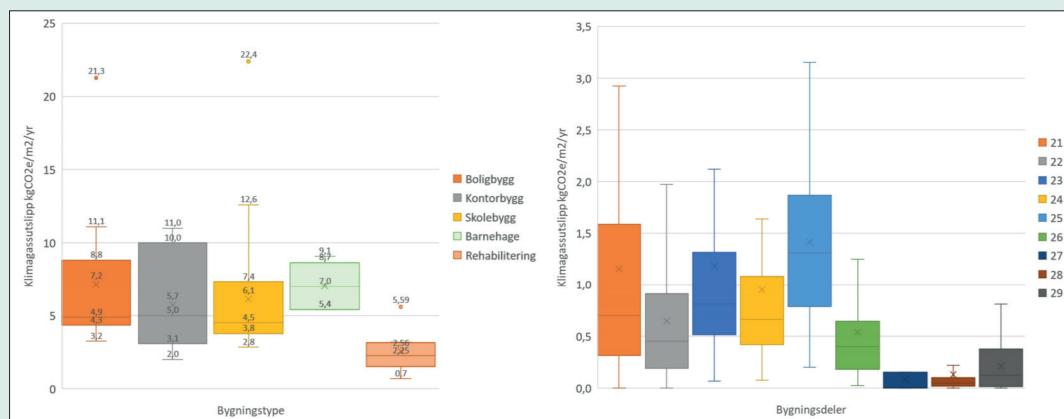

**Figur.** Klimagassutslipp fra materialer i norske bygninger (Wiik et al. 2020). (Bygningsdeler iht NS 3451 i høyre figur er: 21 – grunn og fundamenter 22 – bærekonstruksjon 23 – yttervegger 24 – innervegger 25 – dekker 26 – tak 27 – fast inventar 28 – trapper og balkonger 29 – andre bygningsmessige deler).

# Involving citizens on our journey towards zero emission neighbourhoods



**Daniela Baer**  
Research Scientist  
SINTEF Community



**Caroline Cheng**  
Research Scientist  
SINTEF Community

**Active citizen participation is central in area and urban development, and especially in the development of new concepts such as zero-emission areas.**

Citizen participation has been a recurring theme in urban development. Zero emission neighbourhoods is a new concept that will require active involvement from citizens and relevant stakeholders. The journey towards ZEN involves the interplay of the built environment, infrastructure and user behaviour. A successful process towards ZEN requires citizens' insights, as well as the understanding of planners and developers of their opinions and needs to find the best solutions together.

Therefore, we need innovative approaches to better involve various actors to bring about well-functioning and attractive living environments, both in the planning and construction phases as well as the operational phases. Drawing on design thinking approaches and in collaboration among ZEN researchers and ZEN partners, we have worked towards identifying relevant tools and methods for citizen participation and user-centred innovation for developing ZEN areas.

One result is the "basketball method" (ZEN report no. 25). This method provides structures where citizens can contribute by "throwing in" ideas and provide feedback continuously using different methods and channels. To capture these ideas and feedback systematically by the municipality, it is recommended to establish the role of a central facilitator who is ready to "play ball" with the citizens and bring their ideas and feedback to the fore. This method therefore presents a more dynamic form of citizen participation compared to prevailing often more static approaches.

In another initiative oriented towards better understanding of customer preferences, we are also in the process of developing a workshop tool to capture knowledge among planners and developers of ZEN areas and to better juxtapose them with customers' needs (and vice versa). We have tested the initial design in the Ydalir pilot area with relevant stakeholder such as developers, landowners, city and county municipalities, and energy companies. Plans are underway to further test and finetune this workshop tool in additional pilot areas to provide new thinking for marketing ZEN areas and feasible business models.



**Figure.** The good ZEN solutions for the future of Ydalir were identified by the workshop participants.

# Innbyggerne må tas med på reisen mot nullutslippsområdene

Aktiv innbyggermedvirkning er helt sentralt i område- og byutvikling, og spesielt i utviklingen av nye konsepter som nullutslippsområder.

Det er samspillet mellom det bebygde miljø, infrastruktur og brukerens adferd som fører til at nullutslippsområder kan bli en realitet. En vellykket prosess mot nullutslippsområder trenger innbyggerne og brukernes ekspertise, og planleggere og utviklere som forstår deres meninger og behov for å finne frem til de beste løsningene i felleskap.

Vi trenger innovative tilnærminger for å involvere brukere bedre i prosesser som fører til velfungerende og attraktive områder – både i planleggings-, bygge- og driftsfase og på område-, kommune- og bygg-nivå – alle disse arenaene må spille sammen her. I samarbeid med flere av FME ZENs partnere og eksterne eksperter har vi derfor identifisert verktøy og nye modeller for innbyggermedvirkning og testet metoder for brukersentrert innovasjon ved utvikling av nullutslippsområder.

Et av resultatene er "basketballmodellen" (ZEN rapport Nr. 25). Hovedpoenget her er å etablere arenaer der innbyggerne kan «spille inn» ideer og tilbakemeldinger kontinuerlig ved bruk av forskjellige metoder og kanaler. For at ideene skal fanges opp av kommunen foreslår vi å satse på en tilrettelagt struktur, organisasjonsform og helst en sentral fasilitator som er rigget for å «spille ball» med innbyggerne og deres innspill. Modellen skiller seg dermed fra de ofte mer statiske strukturene i nåvæ-

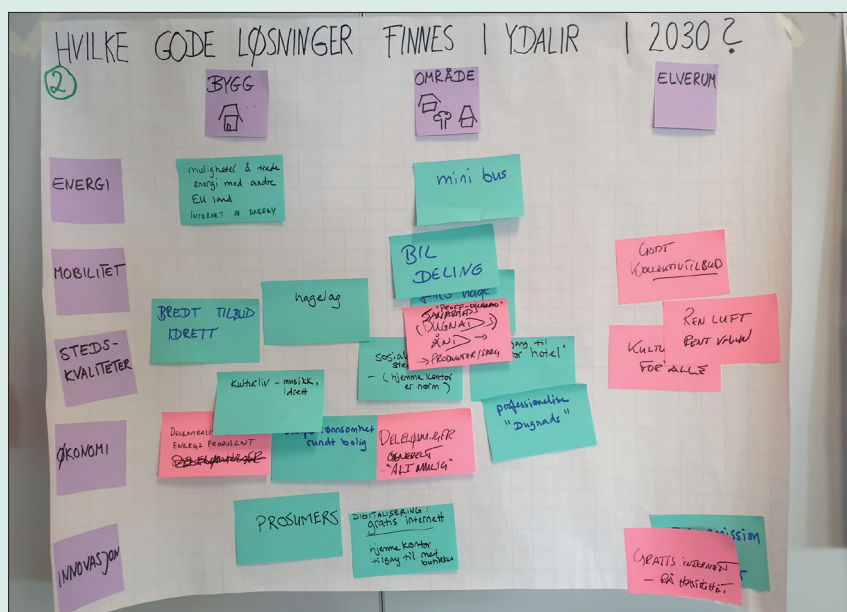

Figur. Workshopdeltakerne i Ydalir presenterer sine tanker rundt markedsføring av nullutslippsområder

rende medvirkningsprosesser, til mer dynamiske former der også innbyggerne og de som faktisk planlegger og driver byen, treffes på nye måter.

For å gi planleggere og utviklere av nullutslippsområder mer kunnskap om kundenes behov har vi utviklet et workshop-opplegg som først ble testet i Ydalir med

utbyggere, grunneiere, Elverum kommune, fylkeskommunen og energiselskaper. Vi brukte designtenkning som en metode for å forstå kundes behov og verdier, og finne ut hvordan nullutslippsområder svarer på disse. I felleskap har vi på denne måten utviklet nye ideer for markedsføring av og forretningsmodeller for nullutslippsområder.

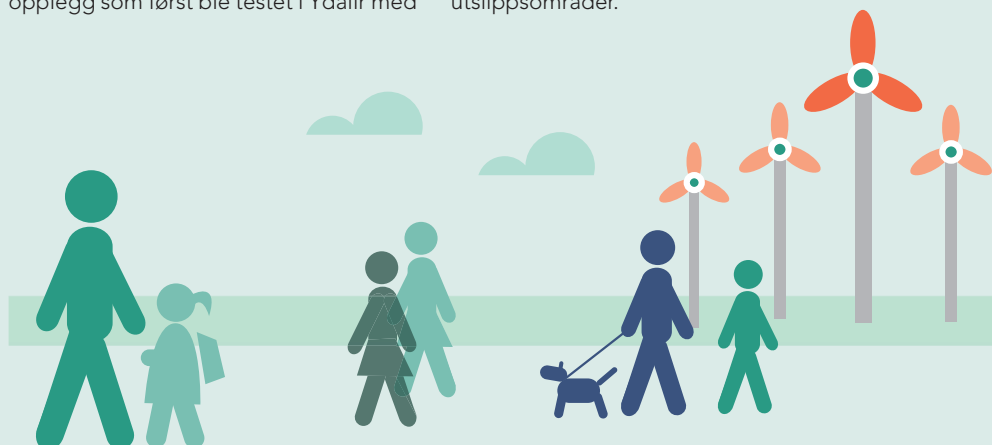

# Domestic hot water – typical profiles



**Synne Krekling Lien**  
Master of Science  
SINTEF Community



**Igor Sartori**  
Senior Research Scientist  
SINTEF Community

**We have compared different methods for separating energy use for heating of hot water from district heating measurements and proposed a new method. All methods have their limitations, but the hybrid method gives the most correct results.**

In Nordic climates, the energy use in buildings is dominated by space heating (SH) and domestic hot water (DHW). Heat load measurements with hourly resolution from smart meters are now becoming the standard. However, in most cases, only the total heat use in the building is metered, without separation into DHW and SH use. The analysis performed in this work is aimed at comparing and verifying different methods for estimating typical DHW load profiles by decomposition of heat load measurements into SH and DHW.

Three methods have been used for the decomposition of the same set of measurements: the seasonal method, the energy signature method and a hybrid summer-signature method. All three methods have limitations, but in this article it is shown that the hybrid method has the closest similarity to measurements.

The measurements analyzed are part of the 'trEASURE' database [1] that consists of more than 300 energy meters representing ca. 2,4 million m<sup>2</sup> of floor area, from

buildings in several places in Norway, subdivided into 11 building categories, both residential and non-residential buildings. A subset from 78 energy meters, comprised of apartments and hotels, was used in this work. The reference datasets, on the other hand, come from a Swedish study where DHW was directly measured on over 1000 apartments, and from the VarmtVann2030 project for hotels.

It is found that the average DHW load profile from measurements is significantly flatter than assumed in the normative values for building performance simulation (SN-NSPEK 3031). There is a large variation in the DHW measurements, but even in the highest decile (the 10% of the apartments with the highest DHW consumption) the difference between morning and evening peaks and mid-day value is not as accentuated as in the norm. The decomposition methods seem to be able to reproduce a daily profile with relatively small morning and evening peaks. However, the summer method and the energy signature method – which are the

most common methods for decomposition of DHW – seem to give particularly high values during the night-time. The proposed hybrid method, although not perfect, gives a better estimate when compared to measured average values.

Involved ZEN partners in this work have been SINTEF Community, NTNU and SINTEF Energy. The research project VarmtVann2030 has been a collaborating partner.

The normative profile probably gives a good dimensioning margin for small buildings, but may lead to oversizing of DHW systems for larger buildings that aggregate several dwellings, such as apartment blocks.

## References

[1] S. K. Lien, K. H. Andersen, K. B. Lindberg, H. T. Walnum, and I. Sartori, "Development and validation of the 'trEASURE' energy measurements database and the 'PROFet' load profiles model (work in progress)," *Int. Build. Perform. Simul. Assoc.* 2021, 2021

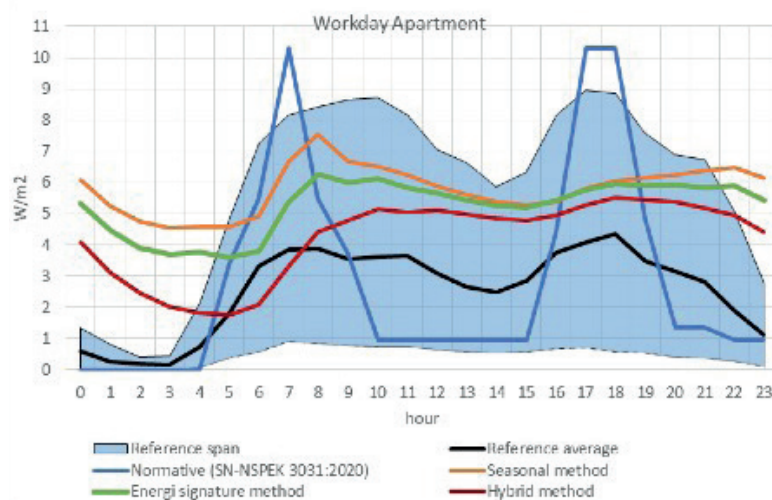

**Figure.** Comparison between different DHW decomposition methods, normative profile and the measurement span (10% – 90%) in the reference dataset.



# Typiske lastprofiler for oppvarming av varmt tappevann i bygg

**Vi har sammenliknet ulike metoder for å skille ut energibruk til varmtvann fra fjernvarme-målinger, og foreslått en ny metode. Alle metodene har sine begrensninger, men hybrid-metoden gir de mest riktige resultatene.**

Romoppvarming og oppvarming av tappevann står for det meste av energietterspørselen i norske bygg. Stadig flere bygg har fått digitale energimålere som måler bruk av fjernvarme på timesnivå. I de fleste bygg som har timesbaserte energimålinger, skilles det derimot ikke på energi til romoppvarming og energi til oppvarming av varmt tappevann. Vi har gjort en analyse der vi har sammenliknet tre ulike metoder for å skille ut energibruk til tappevannsoppvarming fra fjernvarmemålinger i bygg. Vi sammenliknet "sesongmetoden", "energisignaturmetoden" og "hybrid sesongsignaturmetoden (hybridmetoden)".

Metodene har blitt testet på det samme datasettet bestående av målinger av energibruk til oppvarming fra ulike bygg. Analysen har vist at hver av metodene har sine begrensninger, men at hybridmetoden gir den beste tilpasningen når resultatene sammenlignes med målinger av energibruk til tappevannsoppvarming.

Datasettet med energibruksmålinger er hentet fra databasen 'trEASURE' [1] som består av energi-målinger fra mer enn 300 bygg som til sammen utgjør ca. 2,4 millioner m<sup>2</sup> areal. Bygningene er lokalisert på ulike steder i Norge og er fordelt på 11 bygningskategorier og består av både boliger og tjenestebbygg. Målinger fra 78 boligblokker og hoteller fra databasen ble brukt i denne analysen.

Gjennomsnittlige timesprofiler for tappevannsoppvarming i boligblokker og hoteller ble laget ved hjelp av fjernvarmemålinger fra disse byggene og de

tre metodene. De resulterende profilene ble deretter sammenliknet med energimålinger av tappevannsoppvarming fra 1000 svenske leilighetsbygg (for boligblokkene) og energibruk til tappevannsoppvarming i hoteller fra forskningsprosjektet Varmt-Vann2030 (for hotellene).

Analysen viser at gjennomsnittlig timesprofil for energibruk til tappevannsoppvarming er betydelig flattere enn det som blir antatt når man bruker normative verdier i bygningsenergisimuleringer (SN-NSPEK 3031). Energimålinger fra Sverige viser at det er stor variasjon i energibruk til tappevannsoppvarming i ulike leiligheter, men selv i den høyeste desilen (de 10 % av leilighetene med høyeste energibruk til oppvarming av varmt tappevann) er det mye mindre variasjoner i energibruk til tappevannsoppvarming gjennom dagen, sammenliknet med normerte verdier, der det antas en høy topp på morgenen og kvelden. Metodene som har blitt testet ut for å skille ut tappevannsoppvarming fra

fjernvarmemålingene ser ut til å gi daglige timesprofiler mer relativt lave topper for energibruken på morgenen og kvelden. Resultatene viser også at sesongmetoden (som er de fleste brukte metodene for å skille ut tappevannsoppvarming) gir høyere verdier for energibruk til tappevannsoppvarming om natten enn det man kan forvente. Den foreslåtte hybridmetoden gir ikke et perfekt resultat, men metoden gir et bedre estimat for energibruk til tappevannsoppvarming sammenliknet med målte verdier enn de øvrige metodene.

Involverte partnere i dette arbeidet har vært SINTEF Community, NTNU og SINTEF Energi. Forskningsprosjektet Varmt-Vann2030 har deltatt som samarbeidspartner.

Den normative profilen gir sannsynligvis en god dimensjoneringsmargin for små bygninger, men kan føre til overdimensjonering av varmtvannssystemer for større bygninger som samler flere boliger, for eksempel boligblokker.

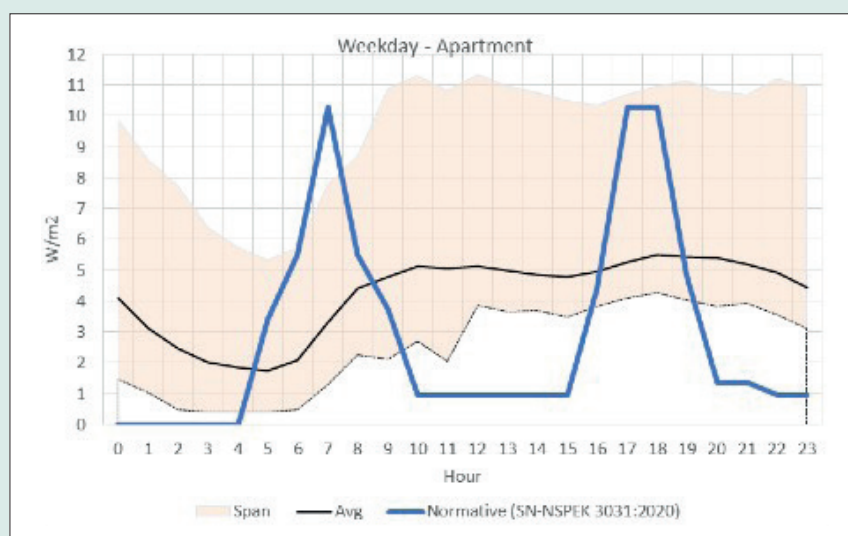

**Figur.** Energibruk til oppvarming av tappevann i leiligheter på hverdager. Sammenlikning av normative simuleringsverdier og variasjon i målte data fra referansedatasettet viser at simulerte verdier i stor grad skiller seg fra målte verdier.

# Possibilities and limitations in current legislations when developing a ZEN area



**Lars Arne Bø**  
Senior adviser  
SINTEF Community



**Magnus Askeland**  
PhD Candidate  
NTNU



**Eivind Junker**  
Associate professor  
Nord University

Obstacles in the regulations can make it difficult to realize zero-emission areas. We have identified issues in the planning and building legislation and in the Energy Act.

From the work in the Ydalir pilot, Elverum Vekst and the municipality of Elverum, have encountered some challenges that signal the regulatory framework is not congruent with the requirements for the transition to zero-emission neighbourhoods.

Our findings show that it is the regulatory framework that prevents development, rather than technical limitations. With regards to the Planning and Building Act, requirements for material use, greenhouse gas emissions (with requirements for certain improvement from TEK17 in percentage), and requirements for passive house standards that cannot be made within the current regulations. When it comes to the Energy Act, it is primarily adapted to individual buildings, and coordination at the neighbourhood level is not incentivized

with current accounting practices when we have different owners of the buildings.

The study revealed several current issues that we have continued to work on. To elaborate the findings, we want to discuss what access planning authorities have to adopt planning regulations on energy requirements for buildings and areas. Preliminary findings indicate that the current regulations allow for relevant planning provisions, but that a change in the law's legal basis will reduce uncertainty and help to advance the purpose of the law.

We also want to shed light on the construction phase, including whether the law covers requirements for the construction phase (such as fossil-free construction sites) in a comprehensive way.



**Figure.** Ydalir School.  
Ole Roald arkitektur.

# Utfordringer og muligheter i dagens lovverk ved etablering av nullutslippsområder



Figur. Perspektiv av Ydalir. Gottlieb Paludan Architects Norge

**Hindringer i regelverket kan gjøre det vanskelig å få realisert nullutslippsområder. Vi har identifisert problemstillinger i plan- og bygningslovgivningen og i energiloven.**

I arbeidet med pilotområdet Ydalir har Elverum Vekst og Elverum kommune støtt på utfordringer som tyder på at lovverket ikke er tilpasset overgangen til nullutslippssamfunnet. På bakgrunn av dette har vi identifisert muligheter og begrensninger for å realisere ZEN-ambisjonsnivået innenfor gjeldende forskrift og lovverk.

Våre undersøkelser viser at det i økende grad er det regulatoriske rammeverket som hindrer utviklingen, heller enn tek-

niske begrensninger. Innenfor dagens regelverk kan man ikke stille strengere krav til materialbruk og klimautslipp enn det som er kravene i byggt teknisk forskrift til plan- og bygningsloven (TEK17). Det er heller ikke mulig å ha reguleringsbestemmelser som stiller krav om passivhus.

Energiloven er i stor grad tilpasset enkeltbygg og dagens regulatoriske rammeverk vanskeliggjør balansering på nabolagsnivå. Koordinering av løsninger på tvers av aktører er problematisk på grunn av insentivstrukturen. Her gir dagens regulatoriske rammeverk manglende samsvar mellom hva som er optimalt hvis man ser på nabolaget under ett, og hva som er fornuftig fra et privatøkonomisk perspektiv.

Studien avdekket flere aktuelle problemstillinger som vi har jobbet videre med. For å utdype funnene ønsker vi å diskutere hvilken adgang planmyndigheter har til å vedta planbestemmelser om energikrav til bygninger og områder. Foreløpige funn tyder på at dagens regelverk gir rom for relevante planbestemmelser, men at en endring av lovens hjemmel vil redusere usikkerhet og bidra til å fremme lovens formål.

Vi ønsker også å belyse hvorvidt plan- og bygningsloven dekker krav til anleggsfasen, slik som fossilfrie anleggsplasser.

# CASE RISVOLLAN: Alternative energy supply scenarios for an existing housing cooperative



**Ruth Woods**  
Research Scientist  
NTNU



**Hanne Kauko**  
Research Scientist  
SINTEF Energy Research



**Ove Wolfgang**  
Research Scientist  
SINTEF Energy Research

**Encouraging housing associations built in the 60s and 70s to make choices that are both energy efficient and sustainable will depend on good examples.**

The Risvollan housing cooperative was built in the 1970's. It has 1113 apartments and a local district heating network supplies heating and hot water. Each apartment pays a set price for heating, independent of the size of the apartment or the number of members in each household. Residents have little influence on how space heating or hot water is supplied, and no responsibility for regulating how much they use. After 50 years of use the heating system is considered inefficient and in need of upgrading.

An interdisciplinary ZEN case analysed two alternative energy supply scenarios:

1. Upgrading the existing district heating system.
2. All-electric heating, including panel heaters, hot water tanks and an automatic control system for load management in each apartment.

The analysis found that the all-electric scenario will be the most cost effective, both with respect to the total energy system costs and the costs for the housing cooperative (Sartori et al. 2020). There were however several uncertain factors in the study, including the assumed energy prices and costs for the required upgrading of heating infrastructure in both scenarios.

In addition, an analysis of potential barriers to the decision-making process was carried out. Three main barriers to the transition were uncovered:

1. Gaining approval could be hindered by two main groups of residents, the elderly who worry about costs and younger residents who worry by environmental implications. Controversy about proposed changes may be expected.
2. The switch will require an adjustment in household energy practices in terms of how they heat their homes and how much hot water they use, as well as engagement in a new billing system. Residents will require support during the transition.
3. Information exchange: An extensive system for information exchange is in place, but there is always someone who has not received information or feels that they have not been heard. Only a minority participate when decisions are made during meetings by the housing cooperative's annual general assembly.

These barriers are equally relevant for decision-making processes in other similar housing cooperatives in Norway, as described in Hauge et al. (2011.) This makes changes proposed for the Risvollan cooperative particularly pertinent. Housing cooperatives built during the 60's and 70's all over Norway are dealing with similar challenges and encouraging them to make choices that are both energy efficient and sustainable will depend on good examples.

## References

Sartori, I., Sørensen, Å.L. (2020) ZEN-case Energisystem Risvollan. ZEN Memo 24, NTNU/SINTEF.  
Hauge, Å.L., Mellegård, S., Amundsen, K.H. (2011). Beslutningsprosesser i borettslag og sameiere: Hva fører til bærekraftige oppgraderingsprosjekter? Prosjektrapport nr. 82. SINTEF akademisk forlag. ISBN 978-82-536-1233-1

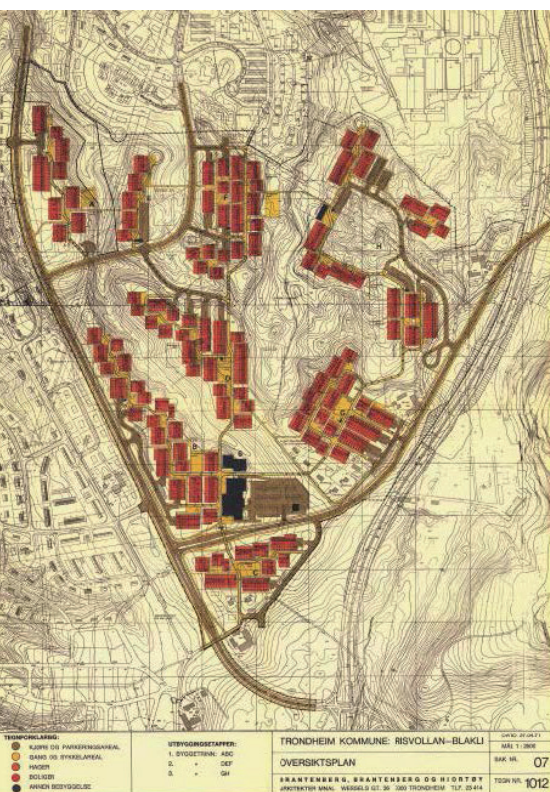

**Figure.** Overview map of Risvollan housing cooperative.

# CASE RISVOLLAN: Alternative energiforsyningsscenarier for et eksisterende borettslag

Å få beboere i borettslag fra 60- og 70-tallet til å ta valg som er både energieffektive og bærekraftige krever gode eksempler.

Risvollan borettslag ble bygget på 1970-tallet. Borettslaget har 1113 leiligheter, og et lokalt fjern-varmenett som forsyner romoppvarming og varmt vann. Hver leilighet betaler en fast pris for oppvarming, uavhengig av størrelsen på leiligheten eller antall medlemmer i husstand. Beboerne har lite innflytelse på hvordan romoppvarming eller varmt vann tilføres, og har ikke noe ansvar for å regulere hvor mye de bruker. Etter 50 års bruk anses varmesystemet som ineffektivt og i behov for oppgradering.

En tverrfaglig ZEN-case har analysert to alternative energiforsyningsscenarier:

1. Oppgradering av eksisterende fjern-varmesystem.
2. Helelektrisk oppvarming, inkludert panelovner, varmtvannstanker og et automatisk kontrollsystem for laststyring i hver leilighet.

Analysen konkluderte at det helelektriske scenariet vil være det mest kostnadseffektive, både med hensyn til de totale energisystemkostnadene og til kostnadene til borettslaget (Sartori et al. 2020). Det var imidlertid flere usikkerhetsfaktorer i studien, inkludert antatte energipriser og kostnader for den nødvendige oppgraderingen av energi-infrastruktur i begge scenariene.

I tillegg ble en analyse av potensielle barrierer for beslutningsprosessen gjennomført.



Figur. Risvollan borettslag. Foto: Åse Lekang Sørensen, SINTEF.

Analysen oppdaget tre hovedbarrierer:

1. Å få godkjenning kan hindres av to hovedgrupper av innbyggere; eldre som bekymrer seg for kostnader og yngre som bekymrer seg for miljømessige konsekvenser. Kontrovers om foreslåtte endringer kan forventes.
2. Bytt av energiforsyningssystem vil kreve en forandring i husholdningenes energipraksis i forhold til hvordan de varmer opp clog hvor mye varmt vann de bruker, samt engasjement i et nytt faktureringssystem. Det vil være behov støtte under overgangen.
3. Informasjonsutveksling: Et omfattende system for informasjonsutveksling er

på plass, men det er alltid noen som ikke har mottatt informasjon eller føler at de ikke er blitt hørt. Bare et mindretall deltar når beslutninger tas under møtene i borettslagets årlige generalforsamling.

Disse barrierene er like relevante for beslutningsprosesser i andre lignende borettslag i Norge, som beskrevet i Hauge et al. (2011.) Dette gjør at endringer som er foreslått for Risvollan borettslag er spesielt relevant. Borettslag bygget på 60- og 70-tallet over hele Norge møter lignende utfordringer, og det å få dem til å ta valg som er både energieffektive og bærekraftige vil være avhengig av gode eksempler.



# A first real implementation of MPC in the ZEB living lab



**Michael Dahl Knudsen**  
Assistant Professor  
Aarhus



**Laurent Georges**  
Associate Professor  
NTNU



**Kristian Skeie**  
PhD Candidate  
NTNU



**Figure.** The ZEB Living Lab's radiator is placed on an inner wall in the Living room. Rated heating power is ca. 2800 Watt at 55/50 °C su.

## Energy flexibility can be used to minimize energy costs, greenhouse gas emissions or peak power.

Energy flexibility requires energy storage. The building fabric is a cheap thermal energy storage, but it has limited storage efficiency. The control of the heating system should thus be smart enough to charge the building at the right time to allow for optimal utilization. Model Predictive Control (MPC) is a key technology to reach this, as it combines numerical optimization and prediction of the future conditions (like weather and price) to find the optimal way to charge the storage while keeping the indoor temperature comfortable for users.

Several studies using simulation have shown the potential of thermal mass activation using MPC. However, the number of MPC implementations in a real building are still limited. In this research work, an MPC has been implemented and tested in the ZEB Living Lab in Gløshaugen campus in Trondheim. The MPC adapted in real-time the temperature set-point of the radiator to charge the building when the energy price is low. The control has been applied during two weeks without residents in the building.

The most demanding part in the design of a MPC is the calibration of the control model. To guarantee a large market penetration, the model should be cheap

to establish, especially in small residential buildings. However, it should remain accurate enough. The main idea was to use black box models, meaning data-driven models where no physical knowledge of the building is required. The experiments have proven that the black box model was accurate enough.

A time-varying price signal was sent to the controller, with high-prices during peak hours, medium and low prices in other periods. Experiments showed that the controller was able to reduce the energy use during peak hours with 80% compared to keeping a constant indoor temperature.

# En første implementering av MPC på ZEB living lab

**Energifleksibilitet kan utnyttes for å minimere energikostnader, utslipp i drift eller kutte effekt.**

Energifleksibiliteten vil være avhengig av muligheten for lagring. Å lagre energi i termisk masse er en billig måte å lagre energi på, men metoden har begrenset utnyttelsesgrad. Derfor må oppvarmings-systemet styres på en smart måte for å lagre

energien i bygget til rett tid, slik at man oppnår høy utnyttelsesgrad. Model Predictive Control (MPC), dvs. prediktiv styring, er en nøkkelt teknologi for dette. MPC kombinerer numerisk optimalisering med prognoser for fremtidens driftsforhold (slik som vær eller energipris). MPC beregner den optimale måten å lade varmelageret på mens den beholder termisk komfort for beboerne.

Flere simuleringsbaserte studier viser potensialet til termisk masselagring ved bruk av MPC. Likevel er antall studier basert på virkelige implementeringer fortsatt begrenset. I et pågående arbeid har en MPC blitt implementert og testet i ZEB Living Lab på Gløshaugen campus i Trondheim. MPC tilpasser settpunkt-temperaturen til en vannbåren radiator i sanntid for å lade bygningen når energiprisen er lav. Styringen ble testet i to uker uten beboere.

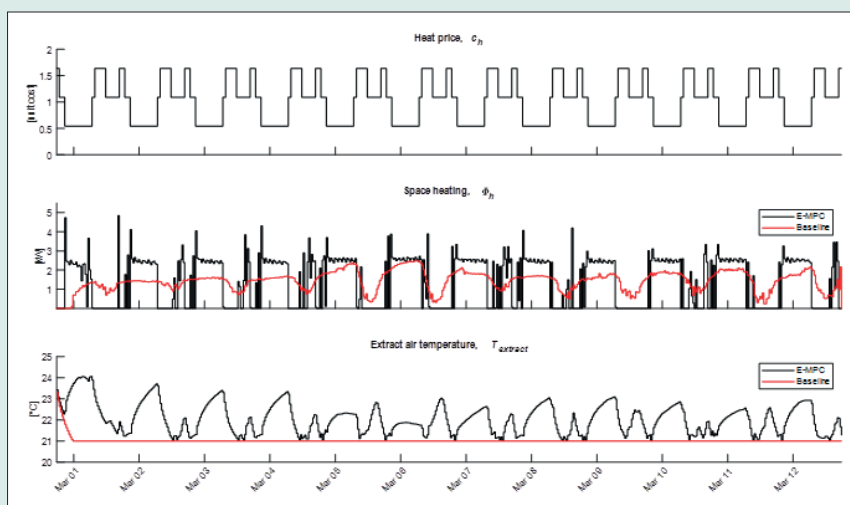

**Figur.** Energiprisen, oppvarmingseffekt og innnetemperatur ved bruk av prognosestyring (MPC) sammenlignet med vanlig styring med konstant innnetemperatur.

Den mest krevende delen av et MPC design er å kalibrere kontrollmodellen. For å oppnå en høy markedsdekning må kontrollmodellen være billig å etablere, spesielt for eneboliger. Samtidig bør modellen være nøyaktig nok. Derfor var ideen å bruke en svart boks-modell, dvs. en databasert modell uten behov for fysisk kunnskap om bygningen. Resultatene viser at svart boks-modellen var nøyaktig nok.

En tidsvariabel pris ble sendt til styrings-systemet, med høy energipris i toppplastimene, middels og lav i andre perioder. Forsøk viser at MPC reduserte energibruken med 80 % i toppplastimene i forhold til styring med konstant innnetemperatur.



# COMMUNICATION AT THE ZEN RESEARCH CENTRE



**Sunniva Mowm Danielsen**  
Communication adviser  
and coordinator  
ZEN, NTNU

The ZEN Research Centre has worked continuously with external and internal communication throughout 2020. There has been substantial scientific and popular scientific publication activity, as the numbers below show.

Because of covid-19 we were forced to think in new ways. Since March of 2020

we have carried out ZEN lunch lectures, seminars, PhD defences and other events digitally on Zoom, Skype and Microsoft Teams.

The ZEN Facebook page [@fmeZEN](#) and Twitter account [@ZENcentre](#) have been updated regularly with recent news, events, and references to publications from the Centre. Our website now has more than 19.000 sessions, and we are currently in the works of translating it and making a Norwegian version.

ZEN researchers and PhD candidates had 10 ZEN lunch lectures physically and on

Skype and Zoom. Partners, researchers, PhD candidates, and postdocs laid plans for the remaining time of the Centre and for the Centre's midway evaluation at our 4<sup>th</sup> partner seminar on the 27<sup>th</sup> and 28<sup>th</sup> of October which we hosted on Zoom. Furthermore, the ZEB laboratory at the Gløshaugen Campus is mostly finished and is undergoing some final tests and calibration experiments. Use of the laboratory is expected to start in March 2021.

24-28<sup>th</sup> of August the ZEN summer school "Time Series Analysis - with a focus on modelling and forecasting in energy

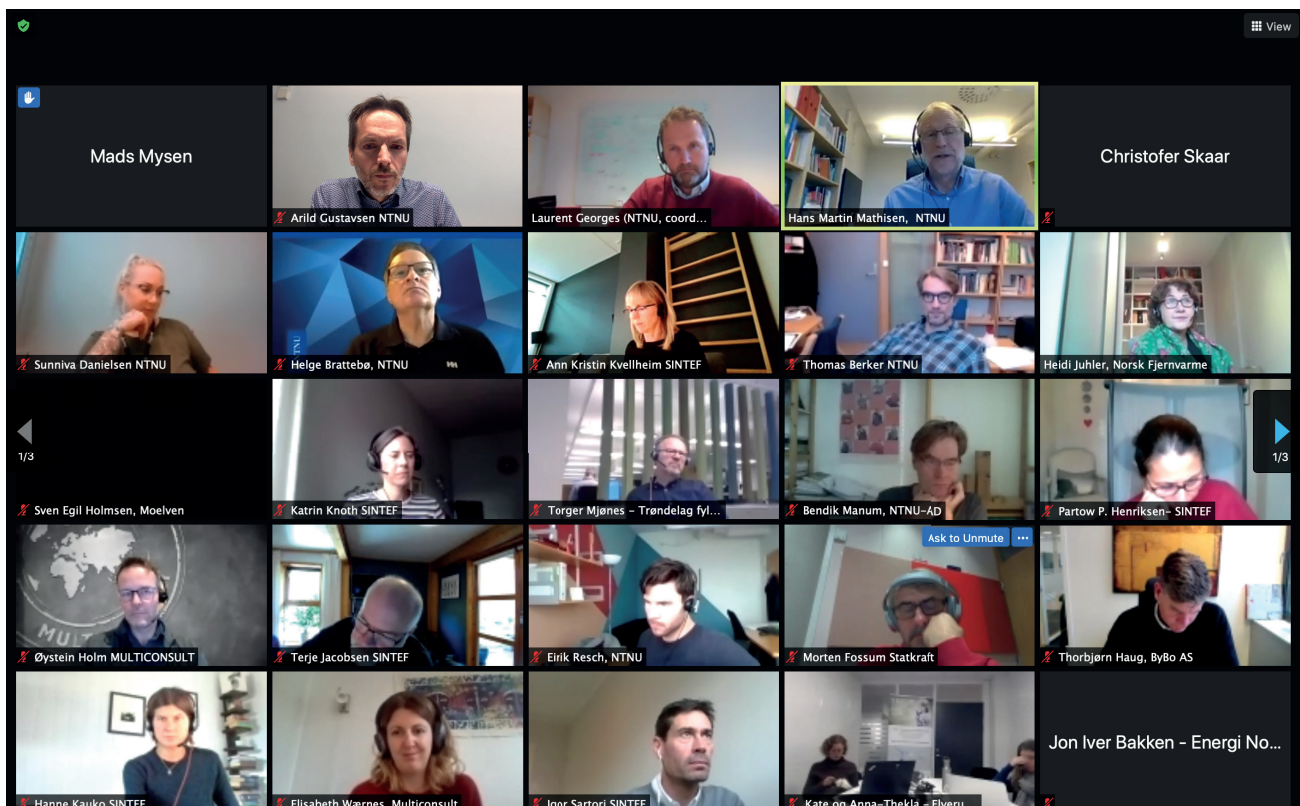

Figure. Screenshot from day one of our digital partner seminar.

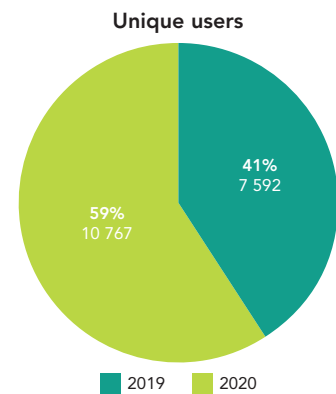



Figure. PhD gathering at Gløshaugen in October.

systems” for PhD candidates, postdocs, industry partners and master students took place online. A workshop on Positive Energy Districts: Definition and Regulatory Frameworks, organized by the ZEN Research Centre and +CityXchange, was completed on the 13<sup>th</sup> of March. The results will be used to influence the European work related to Positive Energy Districts and Cities. Two of our PhD

candidates held their doctoral defenses in 2020. A pilot-to-pilot workshop with researchers and pilot owners was held on the 26<sup>th</sup> of June. Our PhD candidates and post docs held a small, informal seminar on the 23<sup>rd</sup> of October where they presented their results and plans for each other and some of the work package leaders, supervisors and researchers.



## COMMUNICATION ACTIVITIES IN 2020



11

ZEN newsletters

Webpage users:

more than

10,000

see pie chart



52

Scientific publications

40

Unique popular scientific articles and media features



10

ZEN lunch lectures

4

Partner workshops/seminars

## AWARDS

Our Ph.d candidate **Eirik Resch** won the Discovery Innovation Scholarship for his software for carbon footprint calculations in the construction sector. Congratulations!

Congratulations to **Annemie Wyckmans** for being elected "Mission Innovation Champion 2020".

Ph.d candidate **Kasper Emil Thorvaldsen** won the "Roy Billinton Best Student" paper award with the paper "Representing Long-term Impact of Residential Building Energy Management using Stochastic Dynamic Programming". Congratulations!

And congratulations to Ph.d candidate **Xingji Yu** for winning best paper on the BuildSim-Nordic conference with his paper "Influence of Data Pre-Processing Techniques and Data Quality for Low-Order Stochastic Grey-Box Models of Residential Buildings".

## OUR MEETING PLACES

Type of activity	What	Date
Lectures	ZEN lunch lectures in Trondheim and on Skype	10 in 2020
Meetings	Work package meetings	Regularly, 1-2/month
Meetings	ZEN board meetings	4x in 2020: 21.1, 11.3, 3.6, 2.9.
Gathering	Kick-off: EU-project syn.ikia	20 January
Workshop	Workshop on Co2 emissionfactors for ZEN	31 January
Meeting	Delegation from NTE visiting FME ZEN	11 February
Meeting	Breakfast meeting: Lavkarbo byggematerialer	25 February
General Assembly	ZEN General Assembly	11 March
Workshop	Workshop on Positive Energy Districts: Definition and Regulatory Frameworks (joint +CityXchange/ZEN workshop).	13 March
PhD hearing	PhD hearing with Niels Lassen "Subjective data-streams for indoor climate assessment in buildings".	11 June
Summer school	ZEN summer school online	24 August
Seminar	ZEN partner seminar online	27-28 October
Workshop	Life Cycle Assessment (LCA) research activities	27 November
PhD hearing	PhD hearing with Hasan Hamdan Procurement and collaboration in the context of sustainable neighborhood projects"	3 December



# COLLABORATION AMONG OUR PARTNERS



**Terje Jacobsen**  
Vice president research  
SINTEF Community



**Judith Thomsen**  
Research Manager  
SINTEF Community

The ZEN Centre has several regular activities designed to involve and actively follow up all of the ZEN partners; these include the General Assembly, ZEN partner seminars, lunch lectures, and the biannual conference. (The planned conference for 2020 is postponed to the fall of 2021 due to the Covid-19 situation.) In addition, in 2020, the ZEN Centre has organised several workshops/seminars with partners and welcomed several partners for digital visits. There were workshops with the pilot projects, e.g. Pilot-to-pilot meeting in June 2020. Most of the partner meetings and workshops have been done digitally.

To improve partner involvement and their sense of ownership of FME projects, the board introduced the concept of “Case-studies”. Case studies are short term projects or studies owned and lead by one or more partners with the appropriate support from research partners. The experience has been so successful that some of the case studies are being incorporated into revised work plans. The idea for the Case-studies grew out of an internal evaluation conducted in 2019. The results have led to better partner involvement in the centre’s work. The allocated budget for Cases was increased in 2020 due to the Covid-19 situation. This as a compensating measure for reduced activity from the partners in the centre.



**Figure.** A screenshot of the pilot owner meeting discussing how to approach customers and market preferences.

## GLIMPSE FROM A DIGITAL PILOT PARTNER MEETING

The theme of the meeting was how pilots work to disseminate ZEN information to customers and the market. A total of 29 researchers and partners participated to exchange experiences. In the first part, Elverum Vekst (Ydalir), Bodø Municipality (New City – New Airport), ByBo (Zero Village Bergen) and Bærum Municipality (Fornebu) presented reflections on communicating the ZEN goals to the inhabitants and future users of the area. Trøndelag County Municipality and Trondheim Municipality presented a brief update on the status of the pilots Mære Agricultural School and Nidarvoll / Sluppen.

The presentations and subsequent dialogues revealed that the dissemination of ZEN goals to the community is a topic which several of the pilot areas are concerned with. Questions that the partners reflected on included: What does it really mean to live in a zero-emission neighbourhood? What description should be conveyed? How can inhabitants in the neighbourhoods be best engaged and how much?

Following the pilot meeting, the partners for the pilots, Ydalir, Bodø and Bergen established a ZEN case to elaborate further on the topic. The case examines market preferences and is based on a needs assessment of the various actors involved in the development of a ZEN. The goal is to develop a participation tool that enables ZEN partners and future ZEN projects to understand the preferences of future residents. In addition, the

## Planer for innbyggerinvolvering og medvirkning

- Planlagte aktiviteter skal bidra til sterkere synlighet i bybildet, engasjement rundt byutvikling i ny bydel og tilbakemeldinger fra en bredere målgruppe.



## Image/omdømmebygging og kommunikasjon

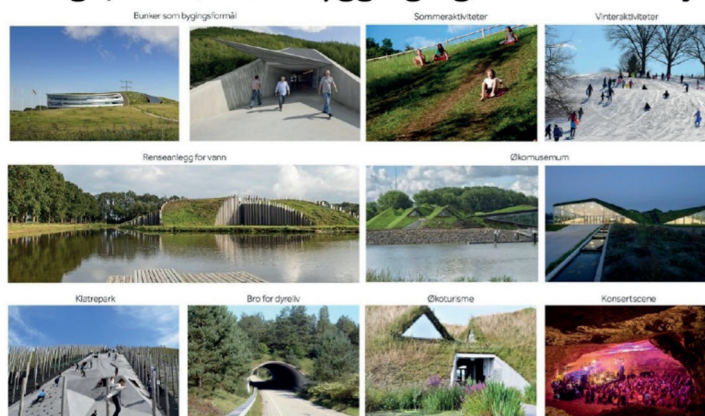

aim is to gain information on how to best communicate and market a ZEN site. The initial phase of the case involves a workshop with the various pilot areas.

In the autumn of 2020, a Living lab was also established at Ydalir, which is

concerned with the inhabitants' and children's thoughts about the good life at Ydalir in Elverum.

The pilot-to-pilot meeting was held digitally. It was very informative to listen to everyone who presented.

# INTERNATIONAL COOPERATION AT THE ZEN RESEARCH CENTRE



**Niki Gaitani**  
Associate Professor  
NTNU



**Annemie Wyckmans**  
Professor  
NTNU

The ZEN Research Centre aims to create new networks with international partners from research, industry, public authorities, and citizen organisations to gain a leading position in Nordic, European, and global society. The main objectives can be summarized as follows:

- Strengthen the international recognition, quality, and relevance of the ZEN Centre's research, development, and innovation activities;
- Increase ZEN Centre's participation in European funding programs, projects and network organizations;
- Contribute to the internationalization of Norwegian research and business;
- Build collaboration with internationally recognized experts.

Researchers in the ZEN Research Centre have been very active towards the EU H2020 program, coordinating or being part in a number of applications, where several have ZEN user partners involved. The ZEN Centre has received funding for, and is coordinating the *Sustainable Plus Energy Neighbourhoods project syn.ikia*, an EU Horizon 2020 innovation action project. Syn.ikia involves 13 research and industry partners from six countries and

will increase the proportion of sustainable neighbourhoods with surplus of renewable energy in different climates and markets in Europe.

NTNU and SINTEF are also part of the newly funded project *iclimabuilt* on *Functional and advanced insulating and energy harvesting/storage materials across climate adaptive building envelopes*, where NTNU leads a work package on Living Labs and is part of the project management team.

ZEN actively cooperates with the +CityxChange project, a H2020-funded project with 32 partners and demonstration activities on Positive Energy Districts in 7 cities across Europe, including Trondheim. The cooperation includes the Sluppen Districts in Trondheim, as well as regular PED Talks with Norwegian and international speakers, on topics such as regulatory frameworks for positive energy districts and climate-neutral cities, the European Framework on Positive Energy Districts, the role of Distributed Ledger Technologies in positive energy districts, and post-COVID recovery measures. On 23 October 2020, the Smart Cities Marketplace launched a new Initiative on Regulatory Frameworks, led by NTNU with co-lead by Trondheim municipality and Powel.

2 European Green Deal proposals were developed, with submission deadline 26 January 2021: one responding to call topic "Building and renovating in an energy and resource efficient way" (LC-GD-4-1-2020) with ZEN as lead, and to call topic "Towards Climate-Neutral and Socially Innovative Cities" (LC-GD-1-2-2020) with ZEN as contributor.

Moreover, the ZEN Research Centre is the Norwegian advisor to the SET-Plan Smart Cities and Communities Action 3.2 Funding Agency Working Group (FAWG), which aims to create 100 plus energy areas (PEDs) by 2025. NTNU is the R&I Chair for the European Stakeholder Group, a role that is in addition to the work of developing a research and innovation program coordinated by the joint program Smart Cities within the European Energy Research Alliance (EERA JP Smart Cities). In these roles, we have also given input to the development of the new HEU Partnerships on Driving Urban Transitions and Clean Energy Transition (in the latter, as co-author of the Strategic Research and Innovation Agenda Chapters "cross-cutting" and "heating and cooling"). SINTEF and NTNU also participate in the European Construction, built environment and energy efficient building Technology Platform (ECTP) which is a leading membership organisation promoting and influencing the future of the Built Environment.

The ZEN Research Centre is involved in several International Energy Agency (IEA) projects such as: IEA EBC Annex 72 Assessing Life Cycle Related Environmental Impacts Caused by Buildings; IEA EBC Annex 81 Data-Driven Smart Buildings; and Annex 83 Positive Energy Districts. These are important for "calibrating" ZEN research topics with the international research agendas and for networking. The ZEN Centre further participates in various projects aimed at countries outside the EU / EEA area, and for example leads a research cooperation project with China on energy called *Key technologies and demonstration of combined cooling, heating and power generation for low-carbon neighbourhoods / buildings with clean energy – ChiNoZEN*, which started in 2020.



Figure. Over the course of syn.ikia's project, four real-life plus-energy demo neighbourhood projects tailored to four different climatic zones will be developed, analysed, optimized and monitored, demonstrating the functionality of the plus-energy neighbourhood concept for the rest of Europe.

NTNU (Annemie Wyckmans) was elected to participate in the Assembly to the Mission Board on Smart and Climate-Neutral Cities, and as Mission Innovation Champion for Norway 2020.

The ZEN Research Centre has an International Scientific Committee (ISC). The ISC is a selective group of high-level experts and consists of:

- Kristina Mjörnell, Business & Innovation Area Manager for Sustainable Cities and Communities at RISE and Adjunct Prof. in Building Physics at Lund University;
- Eva Heiskanen, Prof. at the University of Helsinki at the Consumer Society Research Centre;
- Steve Selkowitz, Senior Advisor for Windows & Envelope Materials Group in Building Technology & Urban Systems Division, at Lawrence Berkeley National Laboratory;
- Lieve Helsen, Prof. of Applied Mechanics & Energy Conversion at KU Leuven.

The ZEN Research Centre has hired two international adjunct professors on topics of particular importance:

- Prof. Henrik Madsen from DTU, expert in probabilistic forecasting;
- Assoc. Prof. Eva Heinen from the University of Leeds, with strong competence in urban form, mobility, and GHG emissions.

Visibility and recognition of the ZEN Centre and its research is generally achieved by presentation of the centre and its results at conferences, in scientific journals and through participation in international networks. Due to the COVID19 pandemic and the travel restrictions the physical events, conferences and other networking activities were replaced by digital workshops. Some indicative online events were:

- Norway – Singapore Science Week. Session Chair. Zero emission buildings, neighbourhoods, and positive energy districts in different contexts, climates and markets. Session Chair on Smart

Cities: Co-Creation of People-Centred, Demand-Driven Solutions for Smart, Sustainable, Positive Energy Cities. 26.10-06.11.2020.

- Forum Wood Building Nordic 2020. Invited speaker on SDG11: Paving the way to zero emission and positive energy neighbourhoods. 13.10.2020.
- Missions in Norway. Knowledge Base Conference 2020. Invited speaker on how Sustainable Plus Energy Neighbourhoods are the Norwegian way forward to achieve "100 Climate neutral cities by 2030". 25.11.2020
- European Congress on Energy Efficiency and Sustainability in Architecture and Urbanism (EESAP 11). Invited speaker for ZEN and syn.ikia project – Sustainable Plus Energy Neighbourhoods. 01.12.2020.







# APPENDICES

---



# PERSONELL

## Management team

Last name	First name	Position	Main research area	Institution
Gustavsen	Arild	Centre director / professor		NTNU
Jacobsen	Terje	Centre liaison / vice president research		SINTEF Community
Solberg	Lasse Hopstad	Financial officer		NTNU
Skjevik	Hanne Kristin	Financial officer		SINTEF Community
Sætersdal Remøe	Katinka	Communication adviser		NTNU
Danielsen	Sunniva Moum	Communications adviser and coordinator FME ZEN		NTNU

## Work package leaders

Last name	First name	Position	Work package	Institution
Brattebø	Helge	WP1 leader / LCA coordination / professor	WP 1	NTNU
Kvellheim	Ann Kristin	WP2 leader / senior adviser	WP 2	SINTEF Community
Mathisen	Hans Martin	WP3 leader / professor	WP 3 & 4	NTNU
Sartori	Igor	WP4 leader / senior research scientist	WP 4	SINTEF Community
Kauko	Hanne	WP6 leader / research manager	WP 5	SINTEF Energi
Thomsen	Judith	WP6 leader / research manager	WP 6	SINTEF Community

## Key researchers

Last name	First name	Position	Work package	Institution
Andresen	Inger	Professor 2	WP 6	NTNU
Baer	Daniela	Researcher	WP 1	SINTEF Community
Bagle	Marius	Researcher	WP 4	SINTEF Community
Berker	Thomas	Living lab coordination / professor	WP 6	NTNU
Boer	Luitzen de	Professor	WP 2	NTNU
Fjellheim	Kristin	Researcher	WP 1	SINTEF Community
Gaitani	Niki	Associate Professor	International cooperation	NTNU
Georges	Laurent	Building/neighbourhood services coordination / assoc. professor	WP 3 & 4	NTNU
Grynning	Steinar	Research manager	WP 3	SINTEF Community
Hamdy	Mohamed	Assoc. prof.	WP 3 & 4	NTNU
Krogstie	John	Professor	WP 1	NTNU
Lien	Synne Krekling	Master of science	WP 1, 4 & 6	SINTEF Community
Petersen	Sobah Abbas	ICT coordination /	WP 1	NTNU
Skaar	Christofer	assoc. professor	WP 3 & 6	SINTEF Community
Tomasgard	Asgeir	Researcher	WP 2	NTNU
Wyckmans	Annemie	Professor		NTNU
Lindberg	Karen B.	Internationalisation	WP 4, 5 & 6	SINTEF Community
Sandberg	Nina Holck	coordination / professor	WP 1	Norway
Walnum	Harald Taxt	Senior researcher	WP 4 & 6	SINTEF Community
Wiik	Marianne	Senior researcher	WP 1 & 6	SINTEF Community

### Visiting researchers

Last name	First name	Topic	Affiliation
Madsen	Henrik	Energy system modelling	Technical University of Denmark
Nordström	Tobias	Researcher	WP 6

### Postdoctoral researchers with financial support from the Centre budget

Last name	First name	Topic and work package
Sinaeepourfard	Amir	Information management of big data to achieve ZEN (WP1)
Stokke	Raymond	Innovation eco-system and green public procurement (WP2)
Tereshchenko	Tymofii	Interaction between zero emission neighbourhoods and district heating systems (WP4)
Woods	Ruth	ZEN living labs (WP6)

### Postdoctoral researchers working on projects in the centre with financial support from other sources

Last name	First name	Topic and work package	Funding
Korsnes	Marius	The role of prosumers in zero emission buildings and neighbourhoods (WP6)	NTNU Energi
Nielsen	Brita	Planning tools for smart energy communities (WP1&6)	Research Council of Norway
Sandberg	Nina Holck	Dynamic modelling of energy use of building stocks (WP1)	NTNU

### PhD candidates with financial support from the Centre budget

Last name	First name	Topic and work package
Askeland	Magnus	Regulatory and economical aspects related to ZEN within a larger energy system (WP5)
Backe	Stian	Transition pathways towards zero emission neighbourhoods (WP2)
Brozovsky	Johannes	The climate dimension and the physical principles of zero emission neighborhoods in Norway (WP1&6)
Favero	Matteo	Thermal comfort enabling thermal flexibility of buildings (WP4)
Hamdan	Hasan Ahmed	Public private collaboration (WP2)
Homaie	Shabnam	Optimal integrated building designs for resilient zero emission neighbourhoods (WP3)
Justo Alonso	Maria	Optimal combination of demand controlled ventilation and heat recovery for ZEB (WP3)
Lausselet	Carine	LCA methods for zero emission neighbourhood concepts (WP1)
Pinel	Dimitri	Local energy system optimization within a larger system (WP5)
Rokseth	Lillian	CO <sub>2</sub> emission and correlation to building form and spatial morphology at neighbourhood scale (WP6)
Satoła	Daniel	Off-grid zero emission building concepts for warm climates (WP3)
Skeie	Kristian	Building energy performance assessment through in-situ measurement (WP3)
Sørensen	Åse Lekang	Smart strategies for energy and power management in neighbourhoods (WP6)
Thorvaldsen	Kasper	The value of buildings energy flexibility in power markets (WP4)
Yu	Xingji	Model predictive control to activate the building energy flexibility (WP4)
Formolli	Matteo	Solar neighbourhood planning (WP1)
Henriksen	Hanne Marit	Representing zero-emission built environments (WP6)
Rizzardi	Victor	Regulatory challenges and opportunities in zero emission neighbourhoods (WP2)
Schön	Peter	Mobilitet

### PhD candidates working on projects in the centre with financial support from other sources

Last name	First name	Topic and work package	Nationality
Annaqeeb	Masab Khalid	Simulation of energy related occupant behaviour in buildings (WP3)	NTNU
Catto Lucchino	Elena	Double skin facades (WP3)	NTNU
Clauss	John	Design and control of heat pump systems in energy flexible residential buildings in cold climate (WP4)	NTNU
Dziedzic	Jakub Wladyslaw	Modeling and simulating energy-related, occupant behavior in residential buildings (WP3)	NTNU
Juhasz-Nagy	Eszter	Improving smart energy community planning through collaborative game development (WP1&6)	NTNU
Lassen	Niels	Evaluation of a method for real time user interaction regarding indoor climate in office buildings (WP3)	Skanska Norway
Moazami	Amin	Energy flexible neighbourhourhoods (WP4)	NTNU
Ness	Maria Coral Albelda-Estelles	Exploring the limits of building bioclimatic design in cold climates (WP6)	NTNU
Resch	Eirik	A framework for analysis of embodied emissions in zero emission neighborhoods (WP1&6)	NTNU
Valler	Thea Marie	Decarbonization of transport in urban China (WP2&6)	NTNU Energy
Sutcliffe	Thomas	Circular economy (WP6)	NTNU sustainability
Catto Lucchino	Elena	Double skin facades (WP3)	Elena
Dziedzic	Jakub Wladyslaw	Modeling and simulating energy-related, occupant behavior in residential buildings (WP3)	Jakub Wladyslaw
Juhasz-Nagy	Eszter	Improving smart energy community planning through collaborative game development (WP1&6)	Eszter
Lassen	Niels	Evaluation of a method for real time user interaction regarding indoor climate in office buildings (WP3)	Niels
Ness	Maria Coral Albelda-Estelles	Exploring the limits of building bioclimatic design in cold climates (WP6)	Maria Coral Albelda-Estelles
Resch	Eirik	A framework for analysis of embodied emissions in zero emission neighborhoods (WP1&6)	Eirik
Valler	Thea Marie	Decarbonization of transport in urban China (WP2&6)	Thea Marie
Sutcliffe	Thomas	Circular economy (WP6)	Thomas



## Other resources associated with the Centre

Last name	First name	Institution	Position	Institution	Funding
Andersen	Tuva	NTNU	ZEN stud.ass.		FME ZEN, others
Andresen	Inger	Asplan Viak	Architect		Others
Bergsdal	Håvard	SINTEF Community	Senior researcher	WP 1	NFR, SINTEF
Bø	Lars Arne	SINTEF Community	Senior researcher	WP 1 & 6	NFR, SINTEF
Cao	Guangyu	NTNU	Prof.	WP 3	NTNU
Carlucci	Salvatore	NTNU	Prof.	WP 3 & 4	NTNU
Clauss	John	SINTEF Community	Researcher	WP 3 & 4	FME ZEN, SINTEF
Farahmand	Hossein	NTNU	Assoc. prof.	WP 4 & 5	NTNU
Fufa	Selamawit Mamo	SINTEF Community	Researcher	WP 1 & 6	FME ZEN, others
Goia	Francesco	NTNU	Assoc. prof.	WP 3	NTNU
Graabak	Ingeborg	SINTEF Energi	Researcher	WP 5	FME ZEN, others
Gullbrekken	Lars	SINTEF Community	Researcher	WP 3	SINTEF Community
Hestnes	Anne Grete	NTNU	Scientific advisor		NTNU
Holmen	Elsebeth	NTNU	Prof.	WP 2	NTNU
Holøs	Sverre	SINTEF Community	Researcher	WP 3	FME ZEN, others
Kolstad	Magne Lorentzen	SINTEF Energi	Researcher	WP 5	FME ZEN, others
Korpås	Magnus	NTNU	Prof.	WP 4 & 5	NTNU
Labonnote	Nathalie	SINTEF Community	Researcher	WP 3	FME ZEN, others
Larssæther	Stig A.	NTNU TSO Sustainability	Coordinator	WP 6	Others
Liu	Peng	SINTEF Community	Researcher	WP 3	FME ZEN, SINTEF
Manum	Bendik	NTNU	Prof.	WP 1 & 6	NTNU
Nord	Natasa	NTNU	Assoc. prof.	WP 4	NTNU
Novakovic	Vojislav	NTNU	Prof.	WP 3 & 4	NTNU
Risholt	Birgit	SINTEF Community	Researcher	WP 3	Others
Strømman	Anders	NTNU	Prof.	WP 1	NTNU
Svendsen	Harald	SINTEF Energi	Researcher	WP 5	SINTEF
Sørnes	Kari	SINTEF Community	Researcher	WP 4 & 6	FME ZEN, others
Thunshelle	Kari	SINTEF Community	Researcher	WP 3	FME ZEN, others
Nocente	Alessandro	SINTEF Community	Researcher	WP3	FME ZEN, others
Andersen	Kamaila Heimar	SINTEF Community	Master of science	WP 4 & 6	FME ZEN, others
Bagle	Marius Eide	SINTEF Community	Master of science	WP 4	FME ZEN, others
Ekambaram	Anandasivakumar	SINTEF Community	Researcher	WP 2	FME ZEN, others
Nitter	Kathrine	SINTEF Community	Senior Corporate Communications Officer / Web Manager	WP 7	FME ZEN, others
Oksavik	Andreas Odne	SINTEF Community	Advisor	WP 3	FME ZEN, others
Gaarder	Jørn Emil	SINTEF Community	Researcher	WP 3	FME ZEN, others
Cheng	Caroline Yeng- Ting	SINTEF Community	Researcher	WP 2	FME ZEN, others
Bergheim	Einar	SINTEF Community	Laboratory Manager	WP 3	FME ZEN, others
Fjellheim	Øystein	SINTEF Community	Research Manager	WP 3,4 & 6	FME ZEN, others
Neumann	Anne	NTNU	Prof.	WP 2	FME ZEN, others
Ersfjord	Eva	NTNU		WP 7	FME ZEN, others
Ahang	Mohammadreza	NTNU	Post.doc	WP 9	FME ZEN, others
Chaudhary	Chamita	NTNU			
Junker	Eivind	NTNU	Researcher	WP 2	FME ZEN, others

### ZEN Scientific Advisory Committee

Last name	First name	Institution
Heiskanen	Eva	University of Helsinki, Finland
Helsen	Lieve	KU Leuven, Belgium
Mjörnell	Kristina	RISE, Sweden
Selkowitz	Stephen	Lawrence Berkeley National Laboratory, USA

### ZEN Scientific Advisory Committee

Last name	First name	Institution
Beus	Lea	
Eldrup	Caroline	An Investment Model for Energy Systems in Zero Emission Neighborhoods - A Multi-Horizon Stochastic Programming Approach
Hammersbøen	Ingrid	
Verås	Håkon Gjenstad	Analyzing Scenario Generation for Energy Market Modeling
Jørgensen	Thomas Berg	Utilizing IoT technology for healthy and energy efficient improvement of existing ventilation systems - Case study of indoor air quality in a primary school classroom using Arduino sensors and CONTAM Simulations
Antonsen	Dan Remi	Increased solar energy utilization in Norwegian agriculture - A case study on the milk barn at Mære Agricultural School
Barth-Stenersen	Liv Marie	Analysis and modelling of heat energy use in an office building utilizing monitoring data and building simulations, EPT, NTNU
Hengebøl	Camilla	A study on optimal utilization of electric heating for buildings, IEL, NTNU
Storlien	E.	Characterizing the demand response potential of thermal heat load in buildings EPT, NTNU
Buseth	Emil Risvik	Energisystemet på Svalbard
Kjenstadbakk	Emilie	A Study of How Integration of Solar Photovoltaic Impact a Housing Cooperative in Norway
Robberechts	Jaro	Developing Software Services in Smart Cities based on Edge to cloud Orchestration
Sebastian Gunnestad	Evans	casEV - Modelling smart power grids with V2G charging as complex systems within an urban context



# STATEMENT OF ACCOUNTS

## FUNDING AND COSTS

Funding	Amount	Total
The research council		20 963 878
The Host institution (NTNU)		12 608 085
<b>Research partners</b>		
SINTEF Energy Research		634 152
Sintef Community		5 335 793
<b>Enterprise partners</b>		8 472 519
ByBo AS	1 097 100	
AS Civitas	151 200	
Boligbyggelaget TOBB	531 395	
Energi Norge AS	354 760	
ÅF Engineering AS/Gottlieb Paludan Architects	122 000	
Asplan viak	707 650	
GK Norge AS	573 543	
Hunton Fiber AS	358 400	
Moelven industrier ASA	363 850	
Norcem AS	460 750	
Norsk fjernvarme	259 780	
NTE Marked	173 600	
Snøhetta Oslo AS	246 053	
Sweco Norge AS	200 000	
Multiconsult ASA	200 000	
Skanska Norge AS	1 741 750	
Elverum tomteselskap AS	930 688	
<b>Public partners</b>		5 197 540
Bergen kommune	200 000	
Bodø kommune	429 310	
Bærum kommune	738 590	
Direktoratet for byggkvalitet	200 000	
Elverum kommune	255 483	
Norges vassdrag og energidirektorat (NVE)	279 000	
Oslo kommune – Plan og bygningsetaten (FutureBuilt)	256 594	
Oslo kommune – klimaetaten	761 500	
Statkraft varme AS	442 300	
Statsbygg	635 600	
Steinkjer kommune	14 400	
Trondheim kommune	367 563	
Trøndelag fylkeskommune	617 200	
Funding transferred to next year		-5 580 000
<b>Total</b>		<b>47 631 967</b>

<b>Cost</b>	<b>Amount</b>	<b>Total</b>
The host institution (NTNU)		21 229 278
<b>Research partners</b>		
SINTEF Energy Research		1 877 200
Sintef Community		16 435 431
<b>Enterprise partners</b>		5 792 519
ByBo AS	947 100	
AS Civitas	101 200	
Boligbyggelaget TOBB	431 395	
Energi Norge AS	204 760	
ÅF Engineering AS/Gottlieb Paludan Architects	22 000	
Asplan viak	507 650	
GK Norge AS	323 543	
Hunton Fiber AS	108 400	
Moelven industrier ASA	113 850	
Norcem AS	210 750	
Norsk fjernvarme	129 780	
NTE Marked	173 600	
Snøhetta Oslo AS	46 053	
Sweco Norge AS		
Multiconsult ASA		
Skanska Norge AS	1 641 750	
Elverum tomteselskap AS	830 688	
<b>Public partners</b>		3 026
Bergen kommune	179 310	
Bodø kommune	238 590	
Bærum kommune		
Direktoratet for byggkvalitet	105 483	
Elverum kommune	79 000	
Norges vassdrag og energidirektorat (NVE)	256 594	
Oslo Kommune - Plan og bygningsetaten (futurebuilt)	511 500	
Oslo kommune - klimaetaten	192 300	
Statkraft varme AS	235 600	
Statsbygg	14 400	
Steinkjer kommune	117 563	
Trondheim kommune	367 200	
Trøndelag fylkeskommune	502	
<b>Total</b>		<b>47 631 967</b>



# PUBLICATIONS IN 2020

## 12 ZEN REPORTS

Backe, Stian; Pinel, Dimitri; Askeland, Magnus; Byskov Lindberg, Karen; Korpås, Magnus; Tomasgard, Asgeir (2021) Zero emission neighbourhoods in the european energy system. ZEN report 30, NTNU/SINTEF

M. Hamdan, Hasan; De Boer, Luitzen; Hamdy, Mohamed (2020) Green public procurement and energy performance contracting. ZEN report 29, NTNU/SINTEF

Kvellheim, Ann Kristin; Moum Danielsen, Sunniva; Nuijten, Anne (2020) Innovasjonsrapport 2020 ZEN Report 28, NTNU/SINTEF

Krekling Lien, Synne; Ahang, Mohammedreza; Byskov Lindberg, Karen; Fjellheim, Øystein (2020) ZEN case study: End user flexibility potential in the service sector ZEN report 27, NTNU/SINTEF,

Rønneseth, Øystein; Haase, Matthias; Georges, Laurent; Thunshelle, Kari; Holås, Sverre Bjørn; Fjellheim, Øystein; Mysen, Mads; Thomsen, Judith (2020) Building services solutions suitable for low emission urban areas ZEN Report 26, NTNU/SINTEF,

Baer, Daniela; Nielsen, Brita Fladvad; Gohari, Savis; Bø, Lars Arne; Junker, Eivind (2020) Nytt blick på medvirkningsprosesser i bærekraftig byutvikling ZEN Report 25, NTNU/SINTEF,

Wiik, M. Kjendseth; Selvig, E.; Fuglseth, M.; Resch, E.; Lousselet, C.; Andresen, I.; Brattebø, H.; Hahn, U. (2020) Klimagasskrav til materialbruk i bygninger ZEN Report 24, NTNU/SINTEF,

Stokke, Raymond A.; Kvellheim, Ann Kristin (2020) ZEN case study: Strategies and business models to support the transition to low-carbon concrete ZEN Report 23, NTNU/SINTEF,

Backe, Stian; Kvellheim, Ann Kristin (2020) Zero emission neighbourhoods – Drivers and barriers towards future development ZEN Report 22, NTNU/SINTEF,

Bremvåg, A., Hestnes, A. G., & Gustavsen, A. (eds.) (2020) ZEN Annual Report 2019 ZEN Report 21, NTNU/SINTEF,

Krekling Lien, S. and Venås, C. (2020) Energy and Power in Ydalir – Testing of Key Performance Indicators for energy and power in a ZEN pilot during the planning phase ZEN Report 20, NTNU/SINTEF,

Matthias Haase, Nicola Lolli and Kari Thunshelle (2020) Renovation concepts for residential buildings ZEN Report 19, NTNU/SINTEF

## 10 MEMOS:

Chaudhary, Shamita; Brattebø, Helge (2020) The role of eco-villages in reaching zero emission neighbourhood (ZEN) goals ZEN Memo 29, NTNU/SINTEF

Woods, Ruth; Thomsen, Judith; Grynning, Steinar; Lolli, Nicola (2020) Electrochromic window system evaluation at Heimdal secondary school ZEN Memo 28, NTNU/SINTEF

Krohn Aasgård, Ellen (2020) Utforming av prissignal i kraftmarkedet ZEN Memo 27, SINTEF

Bø, L.A., Junker, E., Askeland, M. (2020) ZEN og lowverket ZEN Memo 26, NTNU/SINTEF,

Askeland, M. (2020) Web-based solution for eTransport ZEN Memo 25, SINTEF

Sartori, I., Sørensen, Å.L. (2020) ZEN-case Energisystem Risvollan ZEN Memo 24, NTNU/SINTEF

Nuijten, Anne (editor) (2020) Innovasjonsarbeid i FME-ene ZEN Memo 23, NTNU/SINTEF

Bergsdal, Håvard (2020) Environmental assessment of ventilation systems in buildings ZEN Memo 22, SINTEF

Nordström, Tobias; Rokseth, Lillian; Green, Sylvia; Manum, Bendik (2020) ZEN spatial indicators: Evaluation of Kommunedelplan 3 (KDP 3) for Fornebu ZEN Memo 21, NTNU

Nordström, Tobias; Rokseth, Lillian; Green, Sylvia; Manum, Bendik (2020) ZEN spatial indicators: Evaluation of parallel assignments for Sluppen ZEN Memo 20, NTNU

Nordström, Tobias; Rokseth, Lillian; Green, Sylvia; Manum, Bendik (2020) ZEN spatial indicators: Evaluation of Bodø-vest ZEN Memo 19, NTNU

## 15 POPULAR SCIENTIFIC PUBLICATIONS:

Krohn Aasgård, Ellen (2020) Slik kan effektariffer redusere belastningen på strømmettet  
#SINTEFblogg, 10 September 2020

Rambæk, Ida (2020) Planleggerne må bli bedre til å snakke med innbyggerne om byutvikling  
SINTEF, 9 September 2020

Holck Sandberg, Nina (2020) Det er et stort potensial for energi-effektivisering i bygningsmassen!  
E24, 4 September 2020

Hauge, Guro; Schjølseth, Stig (2020) Vi vil ha utslippskutt – ikke papirmølle  
Byggeindustrien, 27 August 2020

Stoknes, Stein (2020) FutureBuilt ZERO – veien mot nullutslipp  
Byggeindustrien, 24 August 2020

Lindberg, Karen Byskov; Sandberg, Nina Holck (2020) Energi inn i arealplanen – en forutsetning for Smarte Byer  
Komunal Rapport, 30 June 2020, further featured in no. of sources: 4

Baer, Daniela; Nielsen, Brita Fladvad; Munkvold, Silje (2020) Quick and dirty designtenking: nytt blikk på innbyggermedvirkning  
#SINTEFblogg, 18 August 2020

Backe, Stian (2020) Effekttarifene bommer hvis de ikke reflekterer nettet  
#SINTEFblogg, 8 June 2020

Kvellheim, Ann Kristin; Stoknes, Stein (2020) Fremtidens bygg skal demonteres og ikke rives  
tu.no, 28 May 2020, further featured in no. of sources: 1

Lausset, Carine (2020) PhD life abroad in the time of Corona  
NTNU Techzone, 22 May 2020

Kvellheim, Ann Kristin; Bramslev, Katharina (2020) Betong er en del av klimaløsningen  
tu.no, 7 April 2020, further featured in no. of sources: 1

Alonso, Maria Justo (2020) Fem tips for god luftkvalitet på hjemmekontoret  
Gemini.no, 27 March 2020

Wiik, Marianne Rose Kjendseth (2020) Norge bør satse på rehabilitering framfor nybygg  
SINTEF.no, 25 March 2020

Baer, Daniela; Thomsen, Judith (2020) Samarbeid er avgjørende for å få til et nullutslippsområde  
#SINTEFblogg, 4 March 2020

Ersfjord, Eva; Wiik, Marianne Rose Kjendseth (2020) Nytt verktøy for å definere nullutslippsområder  
#SINTEFblogg, 13 February 2020

## 25 MEDIA COVERAGE:

Rambæk, Ida (2020) Slik kan boligkjøpere lokkes til nullutslippsområder  
Gemini, 2 desember 2020

Punsvik, Tor (2020) Energi-økonomisering må bli en del av elektrifiseringen  
Harvest Magazine, 1 desember 2020

Bartolomei, Rita Tvede (2020) Spranget fra økologi til bygg  
Fremtidens Byggenæring, 19 november 2020

Lindberg, Karen Byskov; Korpås, Magnus (2020) Vi må elektrifisere nå for å få nullutslipp i 2050  
enerWE, 9 november 2020

Holøs, Sverre B; Thomsen, Judith; Nitter, Kathrine (2020) Personlig oppvarming i nye kontorbygg kan være lønnsomt  
NTB, 27 August 2020

Rønne, Silje (2020) Reduser klimagassutslippene med 50 prosent  
Estate Nyheter, 18 June 2020

Seehusen, Joachim (2020) Strengere klimakrav for bygg – kan gi nye regler for beregning av utslipp  
Teknisk Ukeblad, 18 June 2020

Bergskaug, Elisabeth (2020) EU satser stort på energieffektivisering i coronakrisen – Norge gjør lite  
ABC Nyheter, 25 June 2020

Bærum kommune (2020) Flytårnområdet. Planprogram med byplangrep: tegne opp hvor gatene, parkene og byrommene skal være og plassere viktige  
Bærum kommune, 13 July 2020

News story (2020) Forskere anbefaler klimagasskrav til norske bygninger  
Trønder-Avisa, 10 June 2020

Press release (2020) Anbefaler klimagasskrav til norske bygninger  
NTB info, 9 June 2020, further featured in no. of sources: 2

Interview with Ann Kristin Kvellheim (2020) Snart blir nabolaget ditt smart  
SINTEF.no, 8 June 2020

Interview with Arild Gustavsen (2020) Ekspertintervjuet: Energibruken i bygg kan nær halveres på 30 år  
Energi og Klima, 13 May 2020

News story (2020) Ikke godt nok, Egseth  
Adresseavisen, 9 May 2020

News story (2020) Det er ikke mangel på vindkraft som er problemet  
Glåmdalen, 7 May 2020, further featured in no. of sources: 4

Interview with Marianne Rose Kjendseth Wiik (2020) Rehabilitering i stedet for nybygg kan redusere utslipp med 63 prosent  
Teknisk Ukeblad, 2 April 2020

News story (2020) Alle vi snakker med, ser helst at vi avlyser  
Adresseavisen, 9 March 2020, further featured in no. of sources: 1

News story (2020) Derfor sier vi nei  
Agder Flekkefjords Tidende, 6 March 2020, further featured in no. of sources: 1  
Interview with Ann Kristin Kvellheim (2020) Regulatoriske begrensninger står ofte i veien for nullutslippsbygg  
Enerwe, 27 February 2020

News story (2020) Kartlegger innovative klimaløsninger for bygg  
Mynewsdesk, 21 February 2020, further featured in no. of sources: 1

News story (2020) Frokostmøte med FutureBuilt: Lavkarbo byggematerialer  
Byggfakta, 19 February 2020, further featured in no. of sources: 1

News story (2020) Ingen mangel på fornybar kraft  
Nationen, 13 February 2020, further featured in no. of sources: 1

Press release (2020) ZEN-konferansen 2020: Kan vi lage nabolag uten klimagassutslipp?  
NTB info, 11 February 2020, further featured in no. of sources: 4

News story (2020) Barn + eldre = sant  
Byggfakta, 4 February 2020

Interview with Niki Gaitani and Inger Andresen (2020) Forsker på bærekraftige nabolag  
NTNU Nyheter, 30 January 2020, further featured in no. of sources: 2

News story (2020) I et kupert grunnfjellsområde som Agder vil vindkraftverk medføre varige terrengingrep, og gjerne i de mest uberørte delene av naturen  
Agderposten, 21 January 2020

## 25 JOURNAL ARTICLES:

Askeland, Magnus; Backe, Stian; Bjarghov, Sigurd; Korpås, Magnus (2020) Helping end-users help each other: Coordinating development and operation of distributed resources through local power markets and grid tariffs  
Energy Economics vol. 94, 13 december

Lausset, Carine; Lund, Kristi Marie; Brattebø, Helge (2020) LCA and scenario analysis of a Norwegian net-zero GHG emission neighbourhood: The importance of mobility and surplus energy from PV technologies  
Building and Environment vol. 189, 14 december

Lassen, Niels; Josefsen, Terje; Goia, Francesco (2020) Design and in-field testing of a multi-level system for continuous subjective occupant feedback on indoor climate  
Building and Environment vol. 189, 17 december

Houman Andersen, Poul; Nhu Laursen, Linda (2020) Entrepreneurial strategies for MNCs: A typology  
The International Journal of Entrepreneurship and Innovation, 24 december 2020

Satola, Daniel; Röck, Martin; Houlihan-Wiberg, Aoife; Gustavsen, Arild (2020) Life Cycle GHG Emissions of Residential Buildings in Humid Subtropical and Tropical Climates: Systematic Review and Analysis.  
Buildings, 24 december 2020

Pinel, Dimitri; Korpås, Magnus; B. Lindberg, Karen (2020) Impact of the CO<sub>2</sub> factor of electricity and the external CO<sub>2</sub> compensation price on zero emission neighborhoods' energy system design  
Building and Environment, Vol. 187, 31 October 2020

Pinel, Dimitri (2020) Clustering methods assessment for investment in zero emission neighborhoods' energy system  
International Journal of Electrical Power & Energy Systems, vol. 121, 21 April 2020

Petersen, Sobah Abbas; Petersen, Idar; Ahcin, Peter (2020) Smiling Earth—Raising Awareness among Citizens for Behaviour Change to Reduce Carbon Footprint  
Energies, 13 November 2020

Satola, Daniel; Kristiansen, Audun Bull; Houlihan Wiberg, Aoife; Gustavsen, Arild; Ma, Tao; Wang, Renzhi (2020) Comparative life cycle assessment of various energy efficiency designs of a container-based housing unit in China: A case study  
Building and environment, Vol. 186, 7 October 2020

Brozovsky, Johannes; Gaitani, Niki; Gustavsen, Arild (2020) A systematic review of urban climate research in cold and polar climate regions  
Renewable and Sustainable Energy Reviews, 12 November 2020

Alvarado, Arturo Ortega; Sutcliffe, Thomas Edward; Berker, Thomas; Pettersen, Ida Nilstad (2020) Emerging circular economies: Discourse coalitions in a Norwegian case  
Sustainable Production and Consumption, Vol. 26, 13 Oktober 2020,

Resch, Eirik; Andresen, Inger; Cherubini, Francesco; Brattebø, Helge (2020) Estimating dynamic climate change effects of material use in buildings—Timing, uncertainty, and emission sources  
Building and Environment, Vol. 187, 27 Oktober 2020,

- Gohari, Savis; Baer, Daniela; Nielsen, Brita Fladvad; Gilcher, Elena; Situmorang, Welfry Zwestin (2020) Prevailing Approaches and Practices of Citizen Participation in Smart City Projects: Lessons from Trondheim, Norway  
Infrastructures, 20 April 2020,
- Homaei, Shabnam; Hamdy, Mohamed (2020) A robustness-based decision making approach for multi-target high performance buildings under uncertain scenarios  
Applied Energy, Vol. 267, 21 April 2020,
- Marvuglia, Antonino; Havinga, Lisanne; Heidrich, Oliver; Fonseca, Jimeno; Gaitani, Niki; Reckien, Diana (2020) Advances and challenges in assessing urban sustainability: an advanced bibliometric review  
Renewable and Sustainable Energy Reviews, 6 March 2020,
- Wang, Nan; Satola, Daniel; Wiberg, Aoife Houlihan; Liu, Conghong; Gustavsen, Arild (2020) Reduction Strategies for Greenhouse Gas Emissions from High-Speed Railway Station Buildings in a Cold Climate Zone of China  
Sustainability, 25 February 2020,
- Berker, Thomas; Ruth, Woods (2020) Identifying and addressing reverse salients in infrastructural change. The case of a small zero emission campus in Southern Norway  
International Journal of Sustainability in Higher Education, 7 September 2020,
- Lausset, Carine; Forero Urrego, Johana Paola; Resch, Eirik; Brattembø, Helge (2020) Temporal analysis of the material flows and embodied greenhouse gas emissions of a neighborhood building stock  
Journal of Industrial Ecology, 10 July 2020,
- Li, Yantong; Nord, Natasa; Xiao, Qiangqiang; Tereshchenko, Tymofii (2020) Building heating applications with phase change material: A comprehensive review  
Journal of Energy Storage, Vol. 31, 10 July 2020,
- Kristiansen, Audun Bull; Satola, Daniel; Lee, K; Zhao, Baiyang; Ma, Tengfei; Wang, Ruzhu; Gustavsen, Arild; Novakovic, Vojislav (2020) Feasibility study of an off-grid container unit for industrial construction  
Sustainable Cities and Society, Vol. 61, 20 June 2020,
- Woods, Ruth; Korsnes, Marius (2020) Homemaking in a Living Laboratory: Interpretations of a Zero Emission Housing Solution  
The Journal of Architecture, Design and Domestic Space, 2 July 2020,
- Andersen, Poul Houman (2020) Weaving a strategy for a base of the pyramid market: The case of Grundfos  
LIFELINK  
Business Strategy and the Environment, 23 July 2020,
- Schweiker, Marcel et al. (2020) Review of multi domain approaches to indoor environmental perception and behaviour  
Building and Environment, Vol. 176, June 2020
- Petersen, Sobah Abbas; Koundouri; Phoebe (2020) The Climate Action: Mathematics, Informatics and Socio-Economics Accelerating the Sustainability – Introduction to the Special Theme  
The Climate Action, 13 April 2020
- Carlucci, Salvatore et al. (2020) Modeling occupant behavior in buildings  
Building and Environment, Vol. 174, May 2020



## 5 CONFERENCE PAPERS:

- Woods, Ruth; Berker, Thomas (2020)  
Citizen participation in Steinkjer:  
Stories about the “old NRK building  
at Lø”  
IOP Conference Series: Earth and  
Environmental Science, 9 p.
- Haase, Matthias; Baer, Daniela (2020)  
A closer look at constraints,  
stakeholders and boundary  
definitions in Energy (Master)  
Planning between neighbourhood  
and district  
IOP Conference Series: Earth and  
Environmental Science, 9 p.
- Baer, Daniela; Haase, Matthias  
(2020) Energy Master Planning on  
neighbourhood level: learnings on  
stakeholders and constraints from the  
Norwegian case of Ydalir  
IOP Conference Series: Earth and  
Environmental Science, 9 p.
- Sinaeepourfard, Amir; Krogstie,  
John; Soltvedt, Torbjørn Kirkevik;  
Skuggevik, Thomas (2020)  
Large-Scale Information and  
Communications Technology (ICT)  
Management in Smart Cities based  
on Edge to Cloud Orchestration  
2020 International Conference on  
Omni-layer Intelligent Systems  
(COINS), 8 p.
- Bjarghov, Sigurd; Askeland, Magnus,  
Backe, Stian (2020) Peer-to-peer  
trading under subscribed capacity  
tariffs – an equilibrium approach  
2020 17th International Conference  
on the European Energy Market  
(EEM), 6 p.

## 6 MSC THESES

- Barth-Stenersen L.M. (2020), Analysis  
and modelling of heat energy use in  
an office building utilizing monitoring  
data and building simulations, EPT,  
NTNU.
- Hengebøl C. (2020) A study on optimal  
utilization of electric heating for  
buildings, IEL, NTNU.
- Kyllingstad, M.K. (2020): “Energy and  
GHG Emission Performance Profiles  
at Ravneberget in Bergen – The  
Interplay of Onsite PV Generation,  
Electric Vehicles Sharing and Battery  
Storage for Power Peak Shaving”.  
MSc Thesis, NTNU, Dept Energy and  
Process Engineering
- Ruttenborg, M. (2020): “Life-cycle  
assessment of two building  
alternatives: wood and concrete  
building”. MSc Thesis, NTNU, Dept  
Energy and Process Engineering
- Storlien E.(2020) Characterizing the  
demand response potential of  
thermal heat load in buildings EPT,  
NTNU.
- Trottman, M. (2020): “Analysis of  
material embodied greenhouse gas  
emissions in buildings, aiming to  
influence future building codes”.  
BSc Thesis, NTNU, Dept Energy and  
Process Engineering

### Editors:

Ann Kristin Kvellheim (SINTEF)  
Sunniva Moum Danielsen (NTNU)  
Anne Grete Hestnes (NTNU)  
Arild Gustavsen (NTNU).

### Contributors:

Employees and associated resources of the ZEN Research Centre

### Layout and print:

Skipnes Kommunikasjon AS

# ZEN

Research Centre on  
ZERO EMISSION  
NEIGHBOURHOODS  
IN SMART CITIES

NTNU - Gløshaugen campus  
Alfred Getz vei 3, Central Building 1, 8th floor  
NO-7491 Trondheim, NORWAY



<https://fmezen.no>

ISBN 978-82-536-1699-5 (print)  
ISBN 978-82-536-1691-9 (pdf)